



# AF60 Quick Start Guide

## Package Contents



Dish



Main Arm



Stabilizer Arms (Qty. 2)



Mounting Bracket



Screw



U-Clamp



Flat Washers (Qty. 2)



Lock Washers (Qty. 2)



Flange Nuts (Qty. 2)



Gigabit PoE (24V, 0.5A) with Mounting Bracket



Power Cord



## AF60 Quick Start Guide

- Clear line of sight between airFiber AP and station
- Clear view of the sky for proper GPS operation
- Vertical mounting orientation
- Mounting point:
  - At least 1 m below the highest point on the structure
  - For tower installations, at least 3 m below the top of the tower
- Outdoor, shielded Category 6 (or above) cabling and shielded RJ45 connectors are required for all wired Ethernet connections.
- Surge protection should be used for all outdoor installations. We recommend that you use two Ethernet Surge Protectors, model ETH-SP-G2, one near the airFiber radio and the other at the entry point to the building. The ETH-SP-G2 will absorb power surges and safely discharge them into the ground.



**Note:** For guidelines about grounding and lightning protection, follow your local electrical regulatory codes.

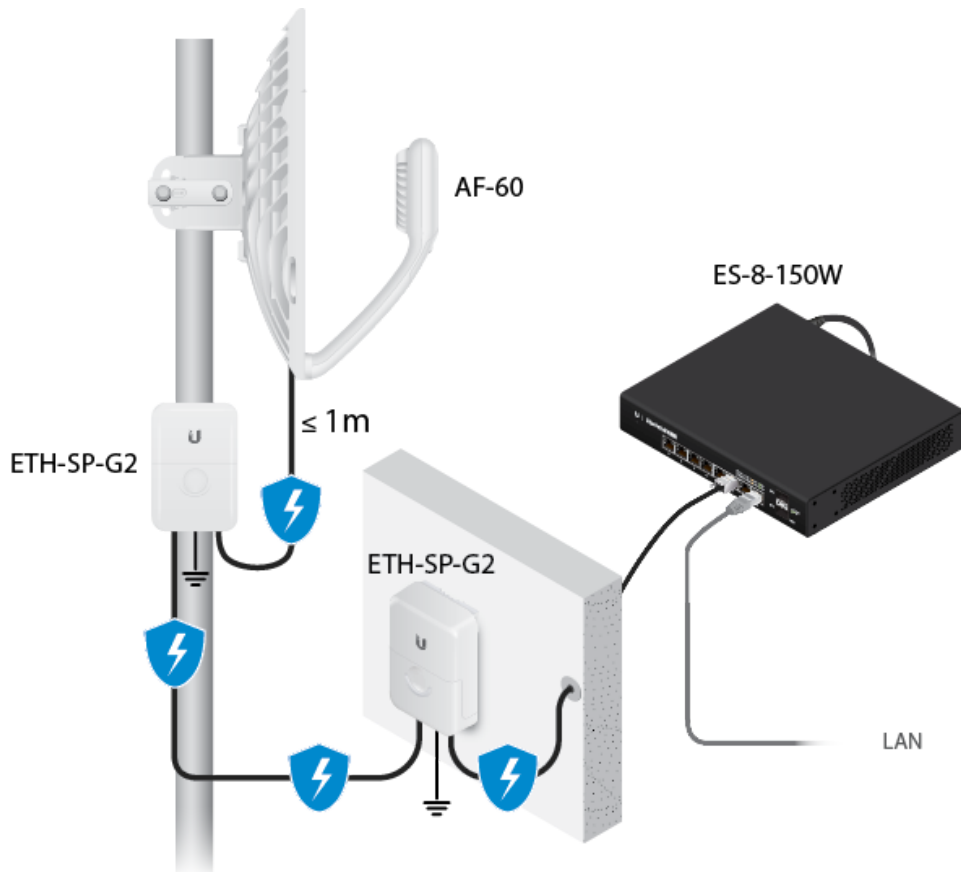

## Hardware Overview



# AF60 Quick Start Guide

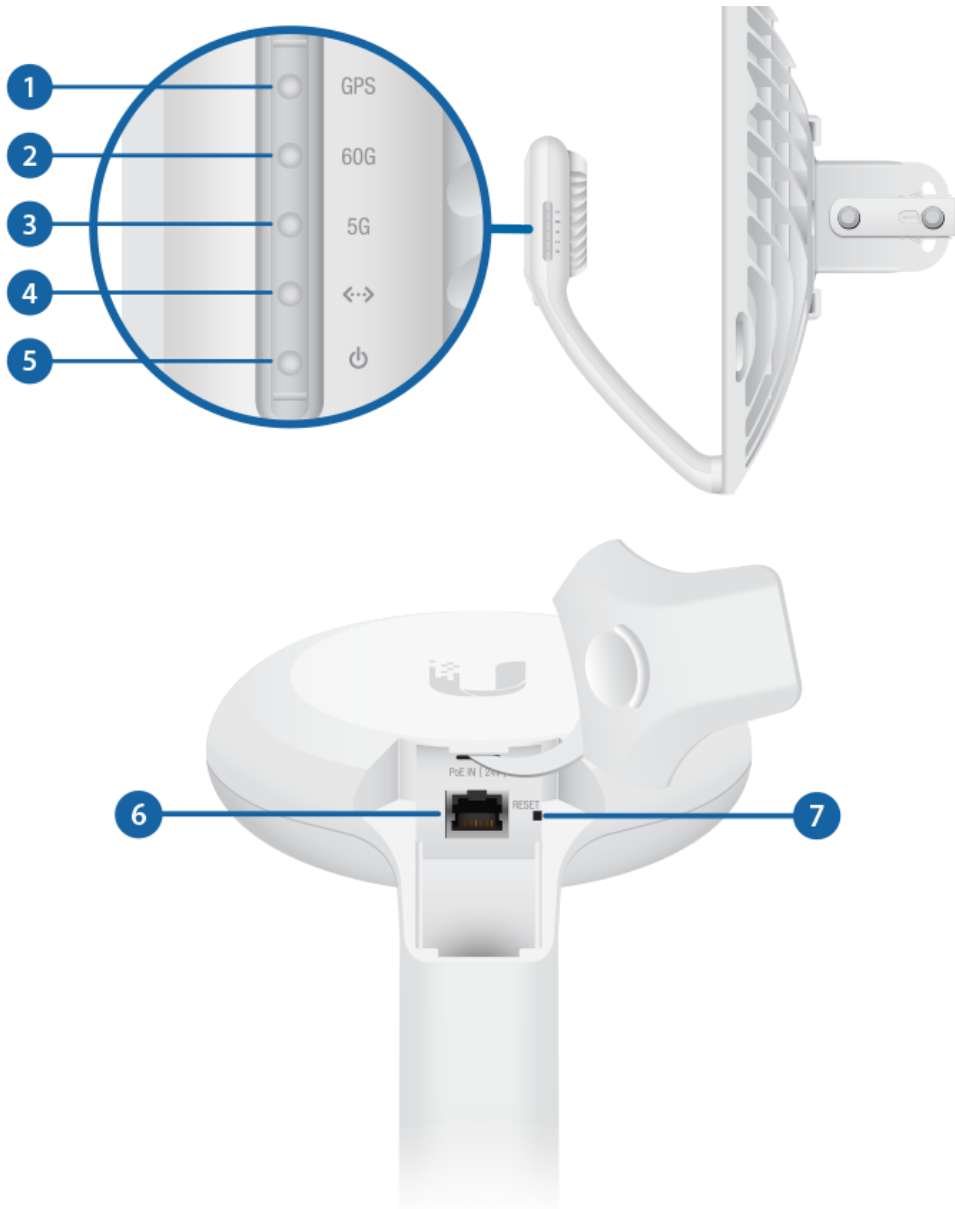

<b>1</b> GPS LED	
Blue	The LED will light blue when the GPS signal strength is sufficient. This requires a minimum of three GPS satellite connections.
<b>2</b> 60G LED	
Blue	The LED will light blue when the 60 GHz link is ready.
<b>3</b> 5G LED	
Blue	The LED will light blue when the 5 GHz link is ready.
<b>4</b> LAN LED	



## AF60 Quick Start Guide

	and flash when there is activity.
<b>5</b> Power LED	
Flashing White	Bootup in progress.
White	Ready for use, not connected to Ubiquiti® Network Management System (UNMS™). See <a href="#">“UNMS Management”</a> .
Blue	Ready for use, connected to UNMS.
Steady Blue with Occasional Flashing	Ready for use, unable to connect to UNMS, check connection to UNMS server.
Quickly Flashing Blue	Used to locate a device in UNMS.
Alternating Blue/White	Firmware upgrade in progress.
<b>6</b> PoE IN	
Gigabit Ethernet PoE port for handling all user traffic and powering the device. Default IP address: 192.168.1.20.	
<b>7</b> Reset Button	
To reset to factory defaults, press and hold the Reset button for more than 10 seconds while the device is powered on. Alternatively, the device may be reset remotely via a Reset button located on the bottom of the Gigabit PoE Adapter.	

## Installation Overview

We recommend configuring both airFiber radios (Access Point and Station) before site installation. Follow the instructions in [“Configuration”](#) for each radio.

## Configuration

### Connecting Power over Ethernet

- 1.



## AF60 Quick Start Guide



2.



3.



## Configuring the Settings

The device is set to DHCP by default, so it will try to automatically obtain an IP address. If that fails, it will use the default fallback IP address, 192.168.1.20. Proceed to the appropriate section, [“DHCP”](#) or [“Fallback IP Address”](#):

### DHCP

Use one of the following methods:

- Set up the DHCP server to provide a specific IP address to the device based on its MAC address (on the label).
- Let the device obtain an IP address and then check the DHCP server to see which IP address was assigned.
  1. Launch your web browser. Type the appropriate address in the address field. Press enter (PC) or return (Mac).

## AF60 Quick Start Guide

airFiber 60

### Please Set Up Your Device

DEVICE COUNTRY  
Select Country

LANGUAGE  
English

TERMS OF USE  
This Ubiquiti Networks, Inc. radio device must be professionally installed. Properly installed shielded Ethernet cable and earth grounding must be used as conditions of product warranty. It is the installer's responsibility to follow local country regulations including operation within legal frequency channels, output power and Dynamic Frequency Selection (DFS) requirements. You are responsible for keeping the unit working according to these rules.

I agree to the Ubiquiti Networks TERMS OF USE, EULA and PRIVACY POLICY

UPLOAD BACKUP CONFIGURATION

CONTINUE

3. Enter a Username and Password, confirm the Password, and click Save.
4. Click the  icon.

airOS AIRFIBER 60 | GPV1.0.0 UNMS

#### Basic Wireless Settings

ACCESS POINT  ON

SSID

COUNTRY United States CHANGE

60GHz FREQUENCY 58320

5GHz FREQUENCY AUTO

5GHz CHANNEL WIDTH 40 MHz

5GHz OUTPUT POWER 25 dBm

#### Wireless Security

WPA2 SECURITY  PERSONAL  ENTERPRISE [?]

WPA2 PRESHARED KEY \*\*\*\*\* SHOW

Advanced

SAVE CHANGES

5. Configure the following settings:
  - a. For one airFiber radio, enable Access Point mode. For the other airFiber radio (the Station), keep Access Point disabled.
  - b. Enter a name in the SSID field. This must be the same on both the AP and the Station.
  - c. In the WPA2 Preshared Key field, enter a combination of alphanumeric characters (0-9, A-Z, or a-z).



**Note:** The key is an alphanumeric password between 8 and 63 characters long.

6. Click Save Changes.
7. Configure each airFiber radio with a unique IP address:
  - a. Click the  icon.



## AF60 Quick Start Guide

IP address.

- **DHCP** By default DHCP client is enabled; if there is a DHCP server on your network, the airFiber radio will receive its address via DHCP.



**Note:** If DHCP client fails, the device will use the fallback IP address: 192.168.1.20

- **Static IP** You can disable the DHCP client and use a static IP address.

c. Click Save Changes.

### Fallback IP Address

1. Ensure that your computer (or other host machine) is connected to the same LAN as the airFiber radio.
2. Configure the Ethernet adapter on your host system with a static IP address on the 192.168.1.x subnet.
3. Launch your web browser. Type `https://192.168.1.20` in the address field, and press enter (PC) or return (Mac).

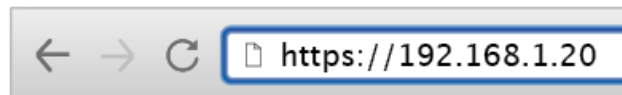

4. Select your Country and Language. You must agree to the Terms of Use to use the product. Click Continue.

5. Enter a Username and Password, confirm the Password, and click Save.
6. Click the icon.

## AF60 Quick Start Guide

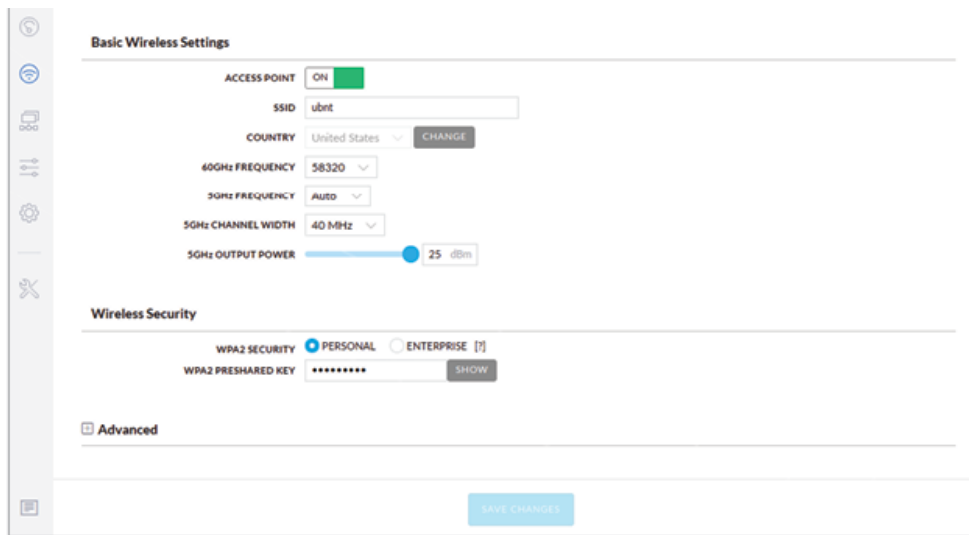

### 7. Configure the following settings:

- a. For one airFiber radio, enable Access Point mode. For the other airFiber radio (the Station), keep Access Point disabled.
- b. Enter a name in the SSID field. This must be the same on both the AP and the Station.
- c. In the WPA2 Preshared Key field, enter a combination of alphanumeric characters (0-9, A-Z, or a-z).



**Note:** The key is an alphanumeric password between 8 and 63 characters long.

### 8. Click Save Changes.

### 9. Configure each airFiber radio with a unique IP address:

- a. Click the  icon.
- b. Review the Network settings to ensure that each airFiber radio has a unique IP address. Each can get its IP address via DHCP, or use a static IP address.
  - **DHCP** By default DHCP client is enabled; if there is a DHCP server on your network, the airFiber radio will receive its address via DHCP.
  - **Fallback IP** If you use the fallback IP address on one radio, you must change the IP Address setting on the other radio. The fallback IP address is: 192.168.1.20
- c. Click Save Changes.

## UNMS Management

You can manage your device using UNMS, which lets you configure, monitor, upgrade, and back up your devices using a single application. Get started at [www.unms.com](http://www.unms.com)

## Installation





# AF60 Quick Start Guide

2.



3.

Optional  
Attach the stabilizer arms for added support.  
(This is recommended for long-range installations.)



# AF60 Quick Start Guide



4.



# AF60 Quick Start Guide



**Note:** The AF60 can mount on either side of the pole. This section shows the AF60 mounted on the left; the procedure for mounting on the right is similar.



*Left*

OR

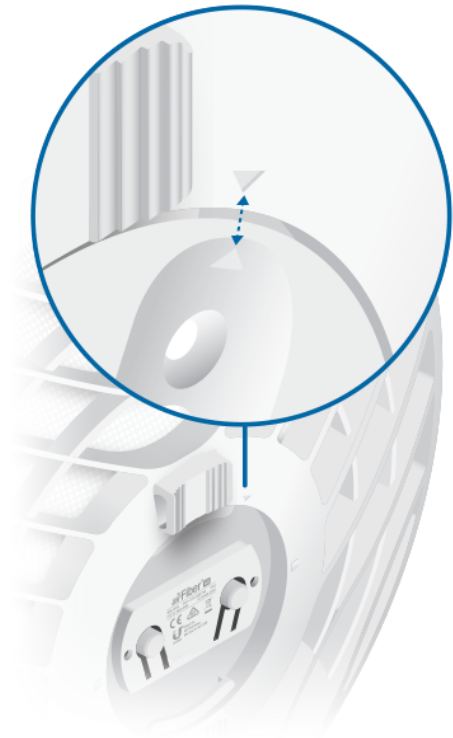

*Right*

5.



# AF60 Quick Start Guide

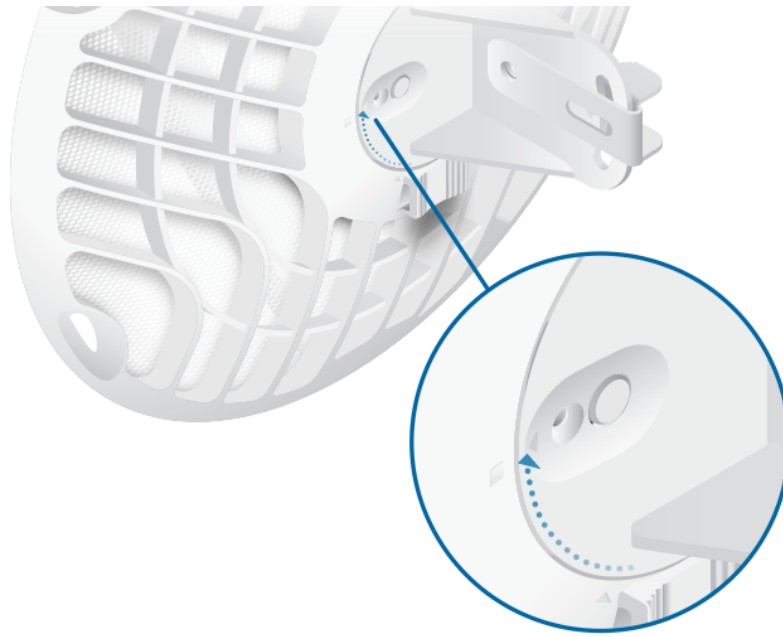

 **Note:** Rotate the Mounting Bracket clockwise until it locks into position.

6.

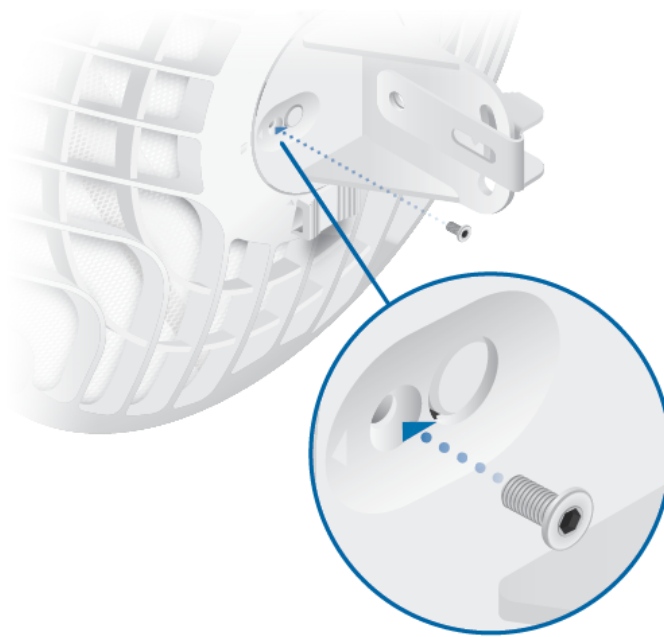

7.



# AF60 Quick Start Guide

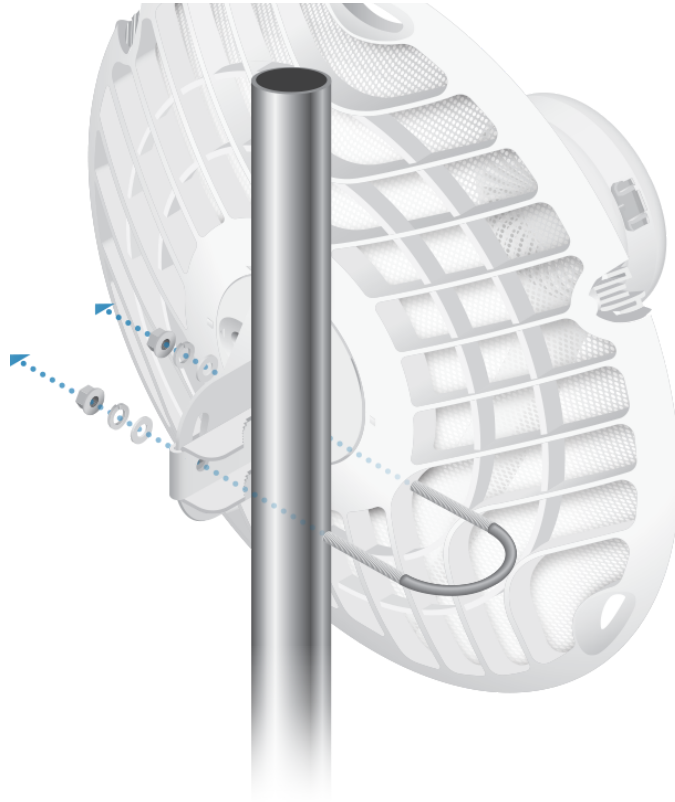

8.



*(Pole not shown)*

9.



# AF60 Quick Start Guide



10.



11.



12.



## AF60 Quick Start Guide



13.

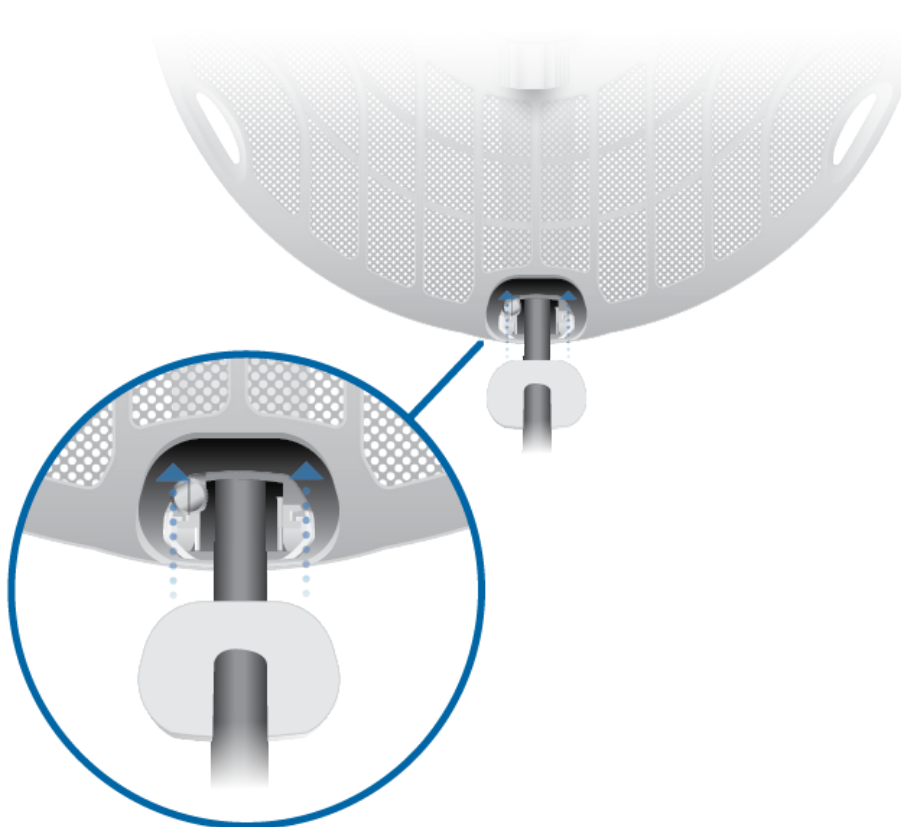

## Connecting Power



**WARNING:** The switch port must comply with the power specifications listed in [“Specifications”](#).





# AF60 Quick Start Guide

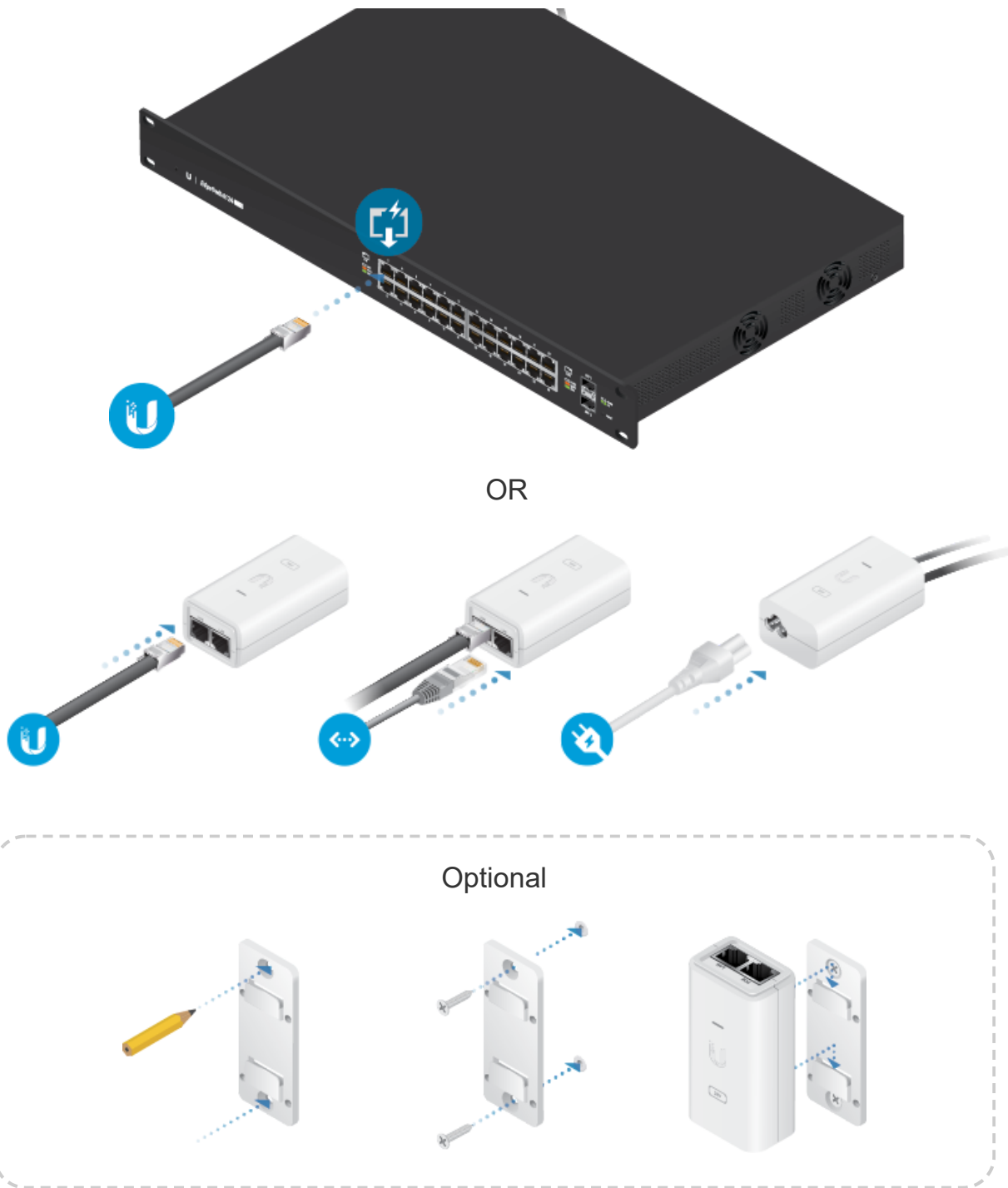

## Alignment

### Tips

- To accurately align the airFiber radios for best performance, you MUST align only one end of the link at a time.
- You may need to use additional hardware to compensate for issues such as the improper orientation of a mounting pole or significant elevation differences between airFiber radios.

## Establishing a Link





## AF60 Quick Start Guide



**Note:** The AP must be aimed first at the Station because the Station does not transmit any RF signal until it detects transmissions from the AP.

1. **AP** Visually aim the AP at the Station by loosening the Flange Nuts on the Mounting Bracket to allow adjustments to the azimuth and the elevation.

Adjust the azimuth:

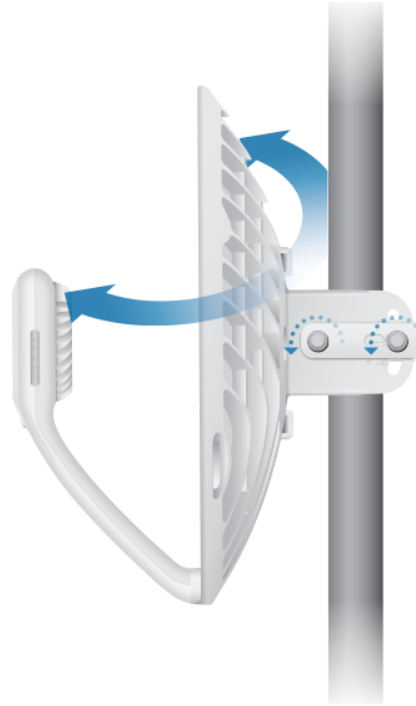

Adjust the elevation:

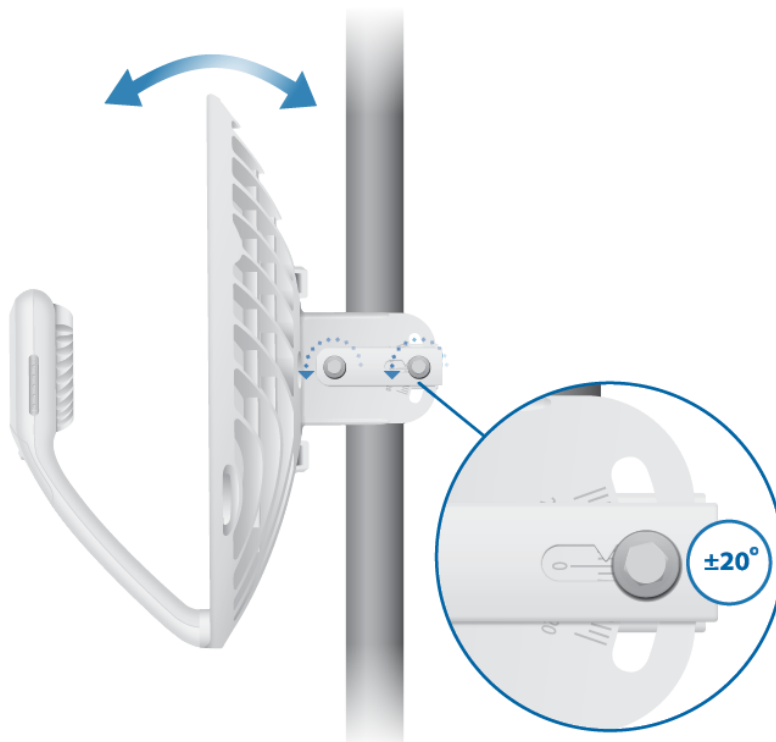

**Note:** Do NOT make simultaneous adjustments on the AP and Station.

## AF60 Quick Start Guide

2. **Station** Visually aim the Station at the AP. To adjust the Station's position, adjust the azimuth and elevation as described in step 1.
3. Open the Configuration Interface, select Tools, and then select Align Antenna.

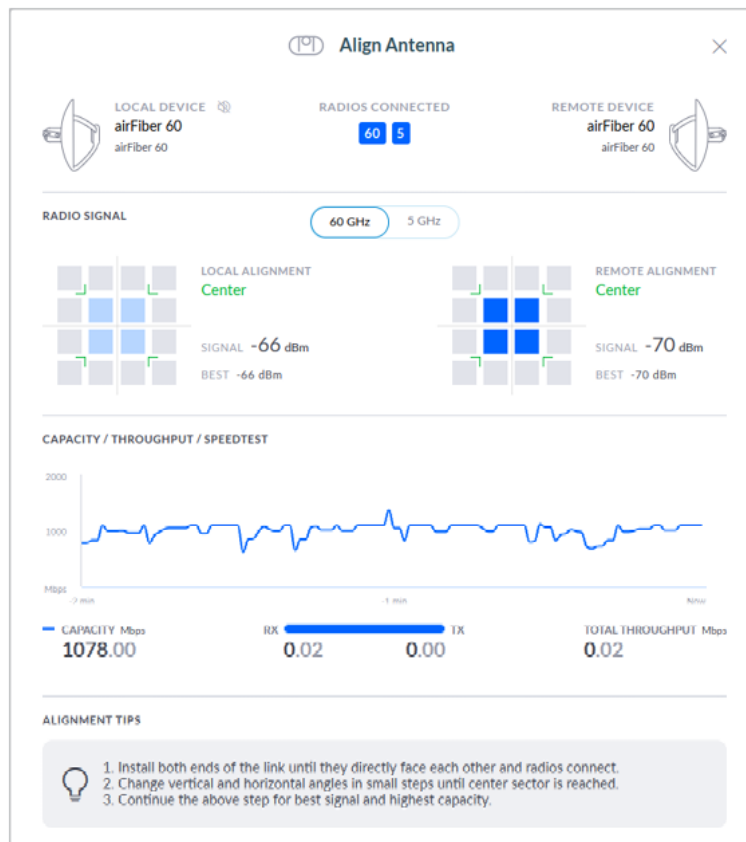

4. Repeat steps 1-2 until you have achieved an optimal link and both the 60G and 5G LEDs are solidly lit blue. This ensures the best possible data rate between the airFiber radios.



**Note:** Maximum signal strength can best be achieved by iteratively sweeping through both azimuth and elevation.

5. Lock the alignment on both airFiber radios by tightening all the nuts.
6. Observe the signal level of each airFiber radio to ensure that the values remain constant while tightening the nuts. If any value changes during the locking process, loosen the nuts, finalize the alignment of each airFiber radio again, and retighten the nuts.

## Installer Compliance Responsibility

Devices must be professionally installed and it is the professional installer's responsibility to make sure the device is operated within local country regulatory requirements.

## AF60 Quick Start Guide

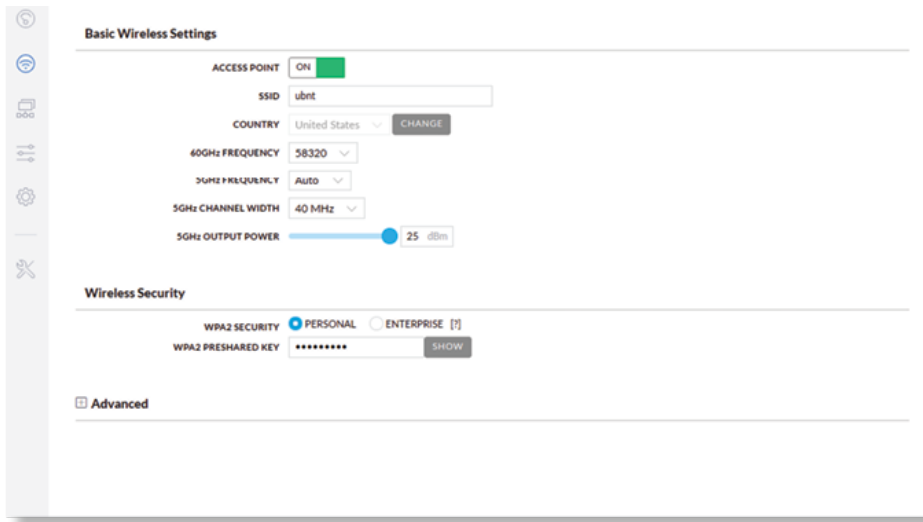

## Antenna

The 5GHz Output Power field is provided to the professional installer to assist in meeting regulatory requirements.

## Specifications

AF60	
Dimensions	413 x 413 x 320 mm (16.26 x 16.26 x 12.60")
Weight	
Without Mount	1.4 kg (3.09 lb)
With Mount	1.8 kg (3.97 lb)
Enclosure	Aluminum, UV-stabilized Polycarbonate
Antenna Gain	
5 GHz	11 dBi
60 GHz	38 dBi
Networking Interface	(1) 10/100/1000 Mbps Ethernet Port
Max. Power Consumption	11W
Power Method	Passive PoE, Pins 4, 5+ and 7, 8-
Power Supply	24VDC, 0.5A Gigabit PoE Adapter (Included)
Voltage Range	+22 to +26VDC
LEDs	Power/Ethernet/5G/60G/GPS
Mounting	Pole Mount (Included)
Wind Loading	420 N @ 200 km/h (94.4 lbf @ 125 mph)
Wind Survivability	200 km/h (125 mph)

## AF60 Quick Start Guide

ESD/EMF Protection	± 24KV CONTACT/AIR
Operating Temperature	-40 to 60° C (-40 to 140° F)
Operating Humidity	5 to 95% Noncondensing
Certifications	FCC, IC, CE

System	
Maximum Throughput	1.8 Gbps
Maximum Range	2+ km
Encryption	WPA2-PSK (AES)/WPA2 Enterprise
OS	airOS GP

Radio	
Max. Conducted TX Power 5/60 GHz Combined	25 dBm
Channel Bandwidth 60 GHz 5 GHz	2160 MHz 20/40/80 MHz

Operating Frequency (MHz)		
US/CA	U-NII-1	5150 - 5250
	U-NII-2A	5250 - 5350
	U-NII-2C	5470 - 5725
	U-NII-3	5725 - 5850
		57,000 - 67,000
Worldwide		5180 - 5875 57,000 - 66,000

Management Radio (MHz)	
Worldwide	2412 - 2472
US/CA	2412 - 2462

## Safety Notices

1. Read, follow, and keep these instructions.
2. Heed all warnings.
3. Only use attachments/accessories specified by the manufacturer.



**WARNING:** Do not use this product in location that can be submerged by water.

**WARNING:** Avoid using this product during an electrical storm. There may be a



## AF60 Quick Start Guide

### Electrical Safety Information

1. Compliance is required with respect to voltage, frequency, and current requirements indicated on the manufacturer's label. Connection to a different power source than those specified may result in improper operation, damage to the equipment or pose a fire hazard if the limitations are not followed.
2. There are no operator serviceable parts inside this equipment. Service should be provided only by a qualified service technician.
3. This equipment is provided with a detachable power cord which has an integral safety ground wire intended for connection to a grounded safety outlet.
  - a. Do not substitute the power cord with one that is not the provided approved type. Never use an adapter plug to connect to a 2-wire outlet as this will defeat the continuity of the grounding wire.
  - b. The equipment requires the use of the ground wire as a part of the safety certification, modification or misuse can provide a shock hazard that can result in serious injury or death.
  - c. Contact a qualified electrician or the manufacturer if there are questions about the installation prior to connecting the equipment.
  - d. Protective earthing is provided by Listed AC adapter. Building installation shall provide appropriate short-circuit backup protection.
  - e. Protective bonding must be installed in accordance with local national wiring rules and regulations.

### Limited Warranty

[ui.com/support/warranty](https://ui.com/support/warranty)

The limited warranty requires the use of arbitration to resolve disputes on an individual basis, and, where applicable, specify arbitration instead of jury trials or class actions.

### Compliance

#### FCC / CAN ICES-3(A)/NMB-3(A)

Changes or modifications not expressly approved by the party responsible for compliance could void the user's authority to operate the equipment.

This device complies with Part 15 of the FCC Rules and ISED Canada licence-exempt RSS standard(s). Operation is subject to the following two conditions.

1. This device may not cause harmful interference, and
2. This device must accept any interference received, including interference that may cause undesired operation.

Le présent appareil est conforme aux CNR d'ISDE Canada applicables aux appareils radio exempts de licence. L'exploitation est autorisée aux deux conditions suivantes :

1. l'appareil ne doit pas produire de brouillage;
2. l'appareil doit accepter tout brouillage radioélectrique subi, même si le brouillage est susceptible d'en compromettre le fonctionnement.



## AF60 Quick Start Guide

reasonable protection against harmful interference when the equipment is operated in a commercial environment. This equipment generates, uses, and can radiate radio frequency energy and, if not installed and used in accordance with the instruction manual, may cause harmful interference to radio communications. Operations of this equipment in a residential area is likely to cause harmful interference in which case the user will be required to correct the interference at his own expense.

This radio transmitter FCC ID: SWX-AF60 / IC: 6545A-AF60 has been approved by FCC / ISED Canada.

The device for operation in the band 5150-5250 MHz is only for indoor use to reduce the potential for harmful interference to co-channel mobile satellite systems.

Les dispositifs fonctionnant dans la bande 5150-5250 MHz sont réservés uniquement pour une utilisation à l'intérieur afin de réduire les risques de brouillage préjudiciable aux systèmes de satellites mobiles utilisant les mêmes canaux.

### IMPORTANT NOTE:

#### Radiation Exposure Statement:

- This equipment complies with radiation exposure limits set forth for an uncontrolled environment.
- This equipment should be installed and operated with minimum distance 71 cm between the radiator and your body.
- This transmitter must not be co-located or operating in conjunction with any other antenna or transmitter.

### AVIS IMPORTANT :

#### Déclaration sur l'exposition aux rayonnements :

- Cet équipement est conforme aux limites prévues pour l'exposition aux rayonnements dans un environnement non contrôlé.
- Lors de l'installation et de la mise en fonctionnement de l'équipement, assurez-vous qu'il y ait une distance minimale de 71 cm entre l'élément rayonnant et vous.
- Cet émetteur ne doit être installé à proximité d'aucune autre antenne ni d'aucun autre émetteur, et ne doit être utilisé conjointement à aucun autre de ces appareils.

### Australia and New Zealand



Warning: This equipment is compliant with Class A of CISPR 32. In a residential environment this equipment may cause radio interference.

### Brazil



**Nota:** Este equipamento não tem direito à proteção contra interferência prejudicial e não pode causar interferência em sistemas devidamente autorizados.

### CE Marking

## AF60 Quick Start Guide



## Country List



AT	BE	BG	CY	CZ	DE	DK	EE	EL	ES	FI	FR	HR	HU
IE	IT	LV	LT	LU	MT	NL	PL	PT	RO	SE	SI	SK	UK

BFWA (Broadband Fixed Wireless Access) members noted in blue



**Note:** This device meets Max. TX power limit per ETSI regulations.



**Note:** Fixed service or any restrictions for authorization of use shall follow local country regulations.

The following apply to products that operate in the 5 GHz frequency range:



**Note:** This device is restricted to indoor use only when operating in the 5150 - 5350 MHz frequency range within all member states.



**Note:** All countries listed may operate at 30 dBm. BFWA member states may operate at 36 dBm.



**Note:** Operation in the 5.8 GHz frequency band is prohibited in BFWA member states. Other countries listed may use the 5.8 GHz frequency band.

## [WEEE Compliance Statement](#)

## [Declaration of Conformity](#)

## Online Resources



# AF60 Quick Start Guide



© 2020 Ubiquiti Inc. All rights reserved.