

## DS-1271ZJ-110

Pendent Mounting Bracket for  
Mini Dome Camera

### Features:

- Aluminum alloy material with surface spray treatment
- Indoor/Outdoor general design
- Internal routed cable design
- Cable entrance is reserved for convenient wiring indoor
- Better water proof design

### Dimension:

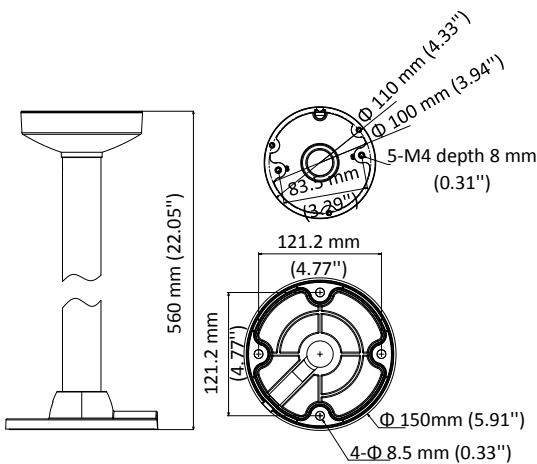

### Order Model:

DS-1271ZJ-110

### Parameter:

Model	DS-1271ZJ-110
Parameters	Pendent Mounting Bracket for Dome Camera
Appearance	Hikvision White
Range of Application	Suitable for dome camera pendent mounting
Material	Aluminum Alloy
Dimension	Φ 150 × 560 mm
Weight	1200 g (2.65 lb.)

### Notice:

- The bracket should be installed on flat wall.
- Waterproof rubber is necessary for outdoor application .
- The wall should be capable of supporting over 3 times as much as the total weight of the camera and the mount.
- The maximum load capacity of the bracket is 3 kg.

### Model Suitable:

DS-2CC51D3S-VPIR, DS-2CD2112-(I), DS-2CD2132-(I)

### Installation Step:

- ① Choose the appropriate wall to install the ceiling plate and thread the cable
- ② Connect pole and adapter; thread cable and screw up
- ③ Screw up and complete the fixation of adapter and pole
- ④ Take off lower dome, inner module and lining

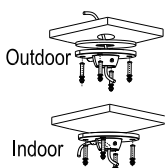

Waterproof rubber is necessary for outdoor application

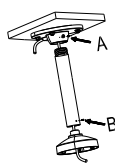

A&B: Tightening Screw

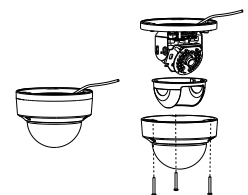
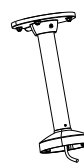

⑤ Thread the cable and fix inner module to adaptor



⑥ Adjust the view angle of camera

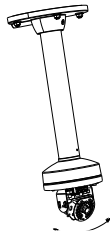

⑦ Install lining and lower dome alternatively to inner module and fix them



⑧ Installation complete.

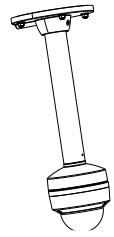

**Note:** The figure of Speed Dome in "Installation Step" is only for your reference; please adhere to our real products.