

Symmetrical Horn Carrier Class Gen 2

HORN ANTENNA WITH N-FEMALE CONNECTORS

Symmetrical Horn CC Antennas Gen2 offer unique RF performance in a compact package. Scalar horn antennas have symmetrical main beam with identical beam width in Vertical and Horizontal plane. Exceptionally small side lobes ensure remarkable interference suppression. HG3-CC Gen2 Antennas are ideal for coverage of areas with clients close to the installation site, where null zone issues exist. High density AP clusters and radio co-location is made possible due to unique radiation patterns and compact size.

Symmetrical Horn CC Antennas Gen2 feature multiple improvements of RF performance and design, namely, optically lighter body and significantly improved bracket. Radome is made of more resistant material, and all of HG3-CC Gen2 antennas use only two radome sizes. HG3-CC Gen2 antenna is equipped with N-female connectors.



TECHNICAL DATA

Radio Connection	2x N Female Bulkhead Connector
Antenna Type	Horn
Materials	UV Resistant polycarbonate, Polypropylene, Aluminium, Zinc, Stainless Steel
Environmental	IP55
Flame Rating	UL 94 HB
Pole Mounting Diameter	30-80 mm
Temperature	-30°C to +55°C (-22°F to +131°F)
Wind Survival	160 km/hour
Wind Loading	44 N at 160 km/hour
Mechanical Tilt	± 25°
Weight	2.3 Kg / 5 lbs – single unit 3.6 Kg / 7.9 lbs – single unit incl. package 18.5 Kg / 40.6 lbs – carton (5 units)
Single Unit	Retail Box: 41.2 x 27.7 x 23.4 cm
5 Units	Carton Box: 119 x 30 x 44 cm

PRODUCT DIMENSIONS

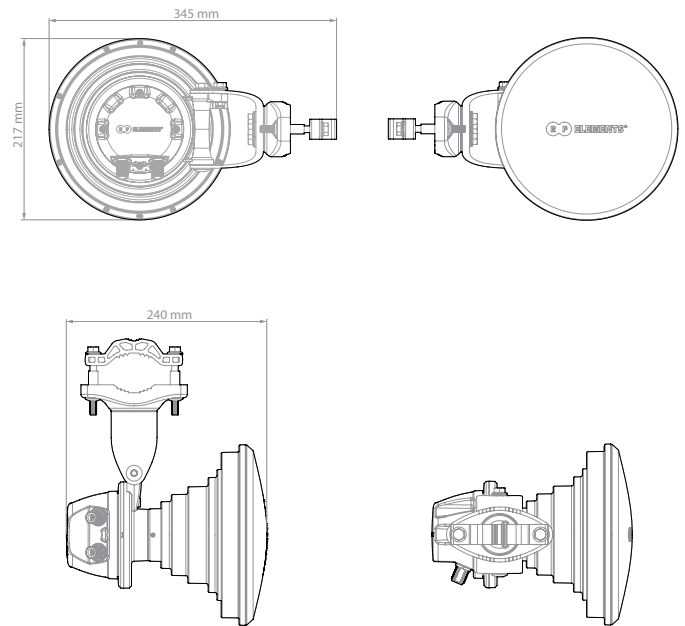

PERFORMANCE

Frequency Range	5180 - 6400 MHz
Gain	16.2 dBi
Azimuth/Elevation BW -3 dB	H 27° / V 27°
Azimuth/Elevation BW -6 dB	H 40° / V 40°
Front-to-Back Ratio	35 dB
VSWR Max 5180-5850 MHz	1.6
VSWR Max 5850-6400 MHz	1.9
Polarization	Dual Linear H + V
Impedance	50 Ohm

AZIMUTH PATTERN



V/H - Port Pattern Azimuth 5.6 GHz

ELEVATION PATTERN

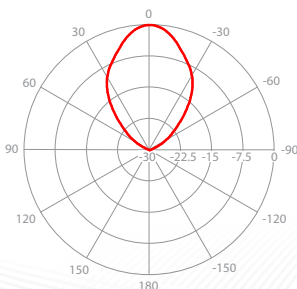

V/H - Port Pattern Elevation 5.6 GHz

GAIN

