



















## ANTENNAS | PUCK-5

# 5-IN-1 TRANSPORTATION & IOT/M2M ANTENNA

2X2 LTE (MIMO), 2X2 DUALBAND WI-FI (MIMO), GPS/GLONASS



 690-960, 1710-2700 & 3200- 3800 MHz	 LTE: 6 dBi GPS: 21 dBi Wi-Fi: 7.5 dBi	 IoT	 4x Omnidirectional	 Machine to Machine	 4G LTE	 5G LTE Ready	 Urban
 2.4-2.5 & 5.0-6.0 GHz	 2x2 MIMO	 GPS included	 IP 68	 Chemical Protection	 -40°C to +80°C	 UL 94 HB	 Rural/Farm
<ul style="list-style-type: none"> <li>• <b>5-in-1 high performance multi frequency</b></li> <li>• <b>2G/3G/4G/LTE antenna (5G Ready)</b></li> <li>• <b>LTE (2 x MiMo), Dualband Wi-Fi (2 x MiMo) &amp; GPS / GLONASS</b></li> <li>• <b>Wideband – covers wide frequency band, incl. the CBRS band</b></li> <li>• <b>Ground plane independent</b></li> <li>• <b>Robust, vandal resistant and water proof (IP68) antenna</b></li> <li>• <b>Ideal for transportation, marine and IoT/M2M use</b></li> <li>• <b>Ultra-versatile mounting options for easy installation</b></li> </ul>							 Marine
							 Transportation
							 IoT/M2M

## Product Overview

Poynting's new PUCK antenna offers a small profile antenna for use in the IoT/M2M, Smart Meter, Smart Utilities, Transportation, Marine and the Agricultural/Farming markets. The PUCK-5 consists of a 5-in-1 antenna system within a single housing, featuring 2x2 MIMO LTE, 2x2 MIMO Wi-Fi (Dual-band 2.4GHz & 5GHz) and GPS/GLONASS. The 2x Cellular MIMO antennas (for 2G/3G/4G) cover the 698MHz to 3800MHz band, this includes the most popular international LTE bands. The antenna provides two separate dual-band Wi-Fi antennas offering concurrent 2.4GHz and 5GHz bands, capable of 802.11n and 802.11ac/ax with 2x2 MIMO. The fifth antenna is a high-performance active GPS/GLONASS system operating at temperatures as low as -40°C. The PUCK exceeds the performance of many competitors due to the attention to design of this high-performance antenna. The radiation patterns of all radiating elements provide an excellent balance between omnidirectionality, pattern diversity and good radiation abilities at the desired elevation, which is often overlooked in such a small size antenna. Despite its small size, this antenna provides excellent performance especially at the higher frequency bands, where performance is critical for LTE throughput and connection stability. This antenna is designed so that both the LTE ports are connected to the router/device to ensure the best performance. Please see other derivatives of the PUCK range that are more suitable for a SISO application.

## Features

- Small & Low-Profile (100mm x h 36mm)
- Careful mechanical design provides ruggedness, corrosion, water, dust resistance (IP68)
- Fire Resistant (complies with ECE-R 118.02)
- UV Stable Enclosure
- Ground plane independent – performs consistently with and without a ground plane
- 5G Ready; includes 3.2GHz to 3.8GHz CBRS Band
- Easy installation; multi implementation options (as standard)
  - Spigot Mount
  - Magnetic Mount
  - Adhesive Tape Mount
  - Bracket Mount

## Application Areas

- Smart Utilities: Smart Power, Gas & Water Metering
- Smart Buildings: Climate control, access control, security, irrigation
- Digital Signage
- Warehouses & Logistic systems
- Industrial factory automation, robotic machinery and other M2M systems
- Transport (Busses, Utility & Public Safety)
- Mining Vehicles & Machinery communications, telemetry and automation (M2M & IoT)
- Agricultural machinery
- Marine: small boats, yachts near to coastlines or inner waters.



### Frequency Bands – Cellular & Wi-Fi

The PUCK-5 is suitable for the following Cellular frequency bands | 690-960 MHz | 1710-2170 MHz | 2300-2500 MHz | 2500-2700 MHz | 3200-3800 MHz | and the following Wi-Fi frequency bands | 2400-2500 MHz | 5000-6000 MHz |

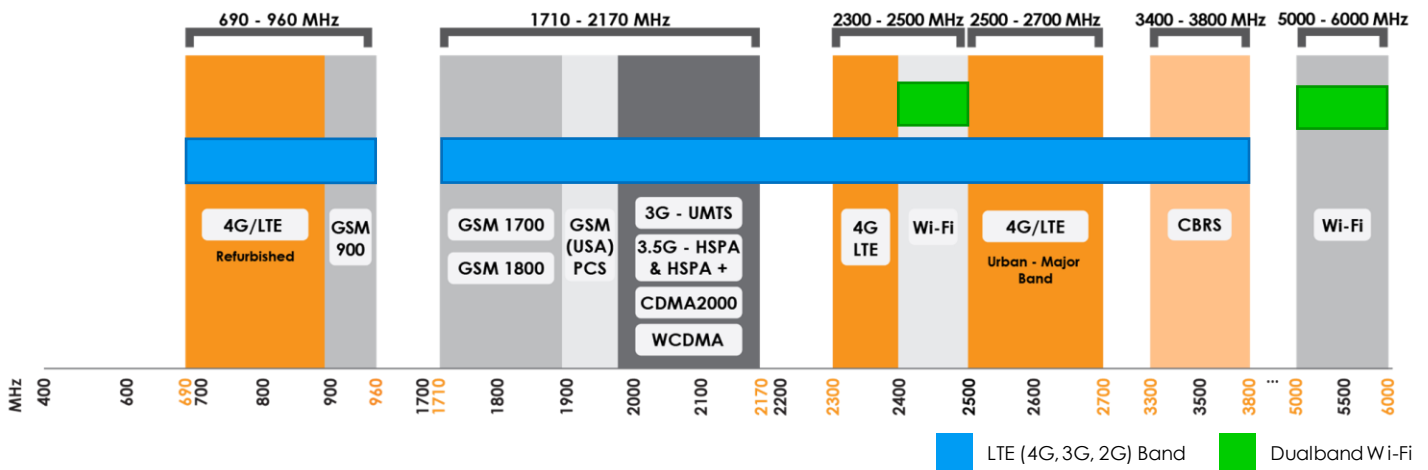

### Antenna Overview

Ports	1 & 2	3 & 4	5
SISO / MIMO	2x2 MIMO	2x2 MIMO	N/A
Frequency Bands	690 MHz - 3800 MHz	2.4 - 2.5 & 5-6 GHz,	1575.42 MHz/1600 MHz
Peak Gain	6 dBi	7.5 dBi	21 dBi
Coax Cable Type	RTK-031	RTK-031	RTK-031
Coax Cable Length	2m	2m	2m
Connector Type	SMA Male	SMA Male (RP-SMA Adapter included)	SMA Male

## Electrical Specifications - Cellular

Frequency bands:	690-960 MHz 1710-2700 MHz 3200-3800 MHz
Gain (max) Port 1 & 2:	6 dBi
VSWR Port 1 & 2:	≤2.5:1
Feed power handling:	10 W
Input impedance:	50 Ohm (nominal)
Polarisation:	Linear Vertical
Coax cable loss:	0.45 dB/m @ 900 MHz 0.71 dB/m @ 2000 MHz 0.79 dB/m @ 2500 MHz 0.9 dB/m @ 3000 MHz
DC Short:	Yes

## GPS/Glonass Antenna Electrical Specifications

Frequency Range (GPS):	1575.42MHz/1600MHz
Gain (Max):	21+/-2dBi
VSWR:	≤1.5:1
DC Voltage:	2.7-3.3 V
DC Current:	5-15mA
Noise Figure:	≤1.5 dB
Nominal Impedance:	50 Ω
Polarisation:	RHCP
Filter Out Band Attenuation:	12dB Min f0+50MHz, 16dBi Min f0-50MHz
Cable:	RTK-031
Connector:	SMA male
Voltage:	2.7 - 3.3V
Max. Power-W:	50

## Wi-Fi Electrical Specifications

Frequency:	2400-2500 MHz 5000-6000 MHz
Gain (Max) Port 1 & 2:	7 dBi
VSWR Port 1 & 2:	≤2:1 over 95% of the band
Feed power handling:	10 W
Nominal input impedance:	50 Ohm (nominal)
Polarisation:	Linear Vertical
Coax cable loss:	0.45 dB/m @ 900 MHz 0.71 dB/m @ 2000 MHz 0.79 dB/m @ 2500 MHz 0.9 dB/m @ 3000 MHz
Path to Ground:	Yes

## Coax Cable & Connector Type -Cellular & Wi-Fi

Cable length:	2m ±5%
Coax cable type:	RTK-031
Connector type:	SMA (Male) RP-SMA Adapters included for Wi-Fi

## Coax Cable & Connector Type - GPS

Cable length:	2m ±5%
Coax cable type:	RTK-031
Connector type:	SMA (Male)

\*The coax cables & connectors are factory mounted to the antenna

## Product Box Contents

Antenna:	A-PUCK-0005-V1-01
Mounting bracket:	Ø20 Threaded Spigots (Up to 60mm clamping thickness), Adhesive Surface Mounting & Optional Magnetic Mount
Adapters:	2x RP-SMA(m) To SMA (f)

## Ordering Information

Commercial name:	PUCK-5
Order product code:	A-PUCK-0005-V1-01
EAN number:	6009880915170

## Mechanical Specifications

Product dimensions	Ø99.3 mm x 36 mm
Packaged dimensions:	150 mm x 150mm x 120mm
Weight:	0.523kg
Packaged weight:	0.654kg
Radome material:	PC+ABS (Halogen free)
Radome colour:	Pantone Black
Mounting Type:	Ø20 Threaded Spigot, Pole, Wall, Surface and Magnetic mount

## Environmental Specifications, Certification & Approvals

Wind Survival:	<220 km/h
Temperature Range (Operating):	-40°C to +80°C
Environmental Conditions:	Outdoor/Indoor
Water ingress protection ratio/standard:	IP 68
Salt Spray:	MIL-STD 810F/ASTM B117
Operating Relative Humidity:	Up to 98%
Storage Humidity:	5% to 95% - non-condensing
Storage Temperature:	-40°C to +80°C
Flammability Rating:	UL 94-HB, ECE-R118.02 Certified cables
Impact resistance:	IK 10
Product Safety & Environmental:	Complies with CE, EN, CSA, RoHS and IEC standards, E-mark certified



Technical Drawings

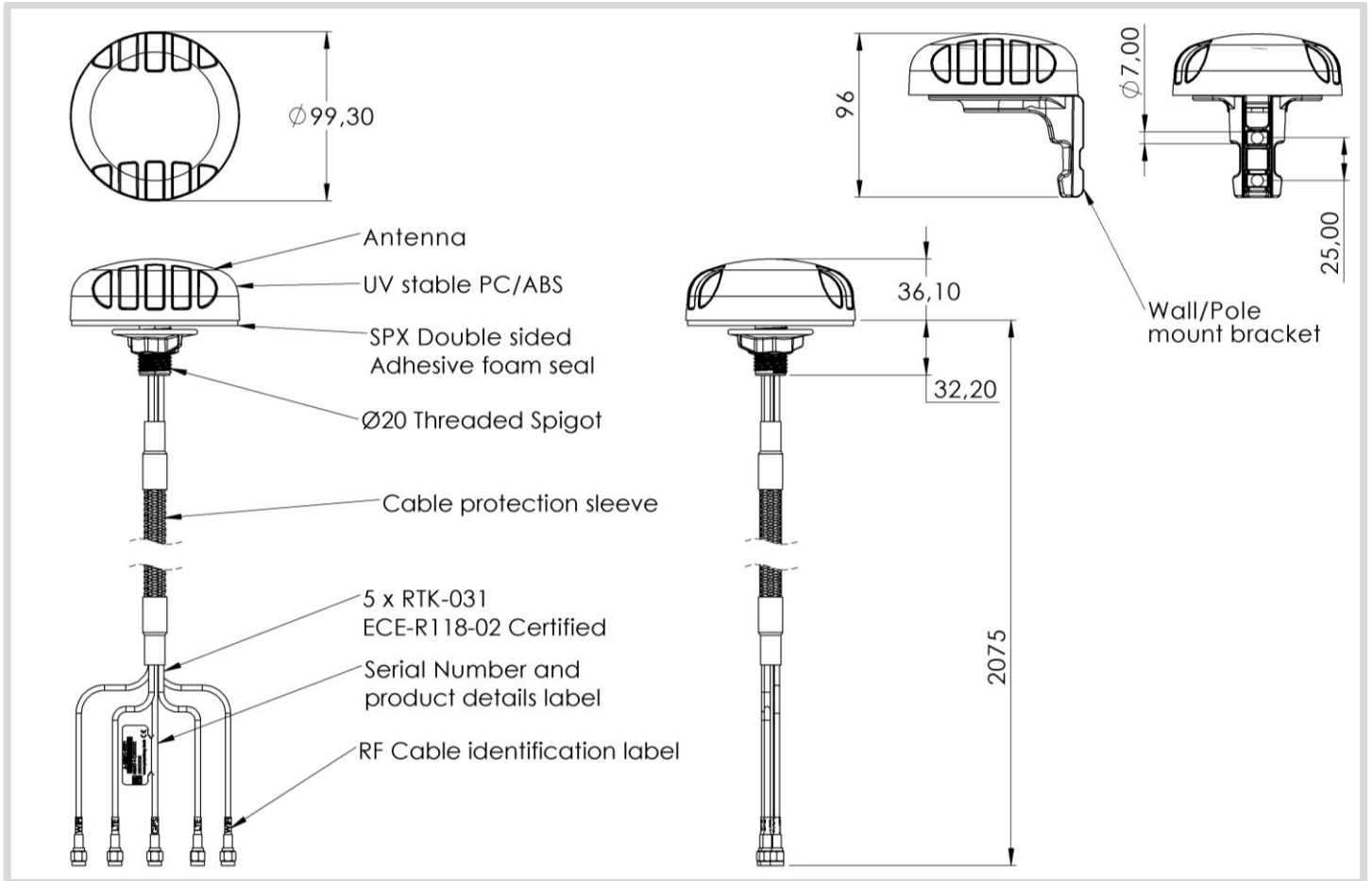

**Antenna Performance Plots**

**VSWR: Cellular Antenna**

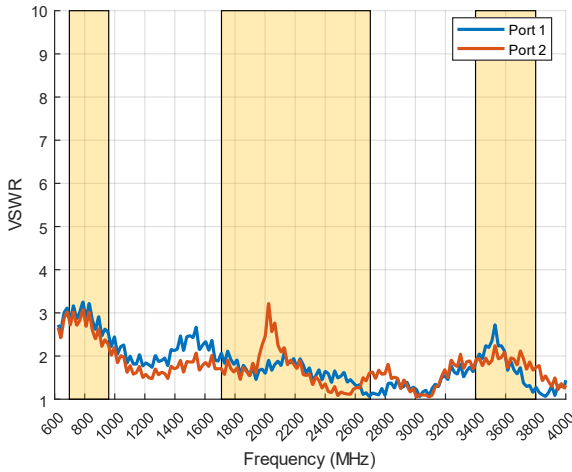

**Voltage Standing Wave Ratio (VSWR)\***

VSWR is a measure of how efficiently radio-frequency power is transmitted from a power source, through a transmission line, into a load. In an ideal system, 100% of the energy is transmitted which corresponds to a VSWR of 1:1.

The PUCK-5 delivers superior performance across all bands with a VSWR of  $\leq 2.5:1$  over 85% of the band

\*Measured with 2m low loss cable

\*Measured with 50Ω load terminated to unused port

**Gain: Cellular Antenna**

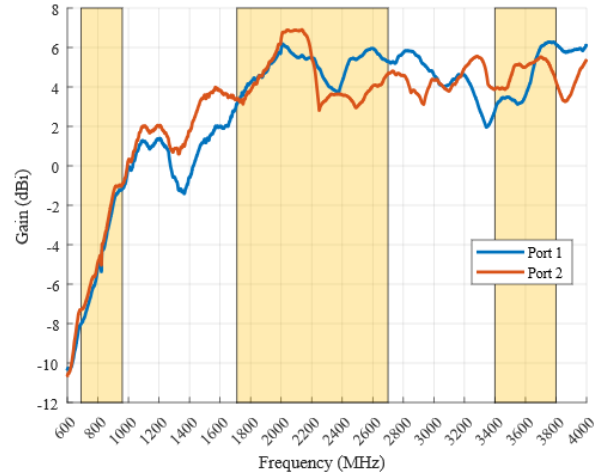

**Gain in dBi**

6 dBi is the peak gain across all bands from 690-960, 1710-2700 & 3400-3800 MHz

Peak Gain @ different bands:	-1 dBi @690-960MHz
Peak Gain @ different bands:	6.0 dBi @ 1710-2700MHz
Peak Gain @ different bands:	6.0 dBi @3400-3800MHz

**VSWR: Wi-Fi Antenna**

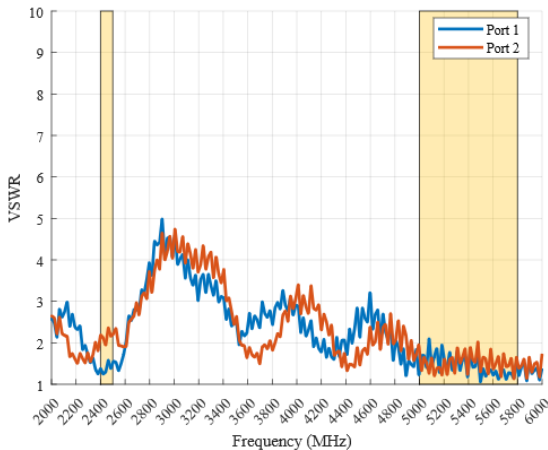

**Voltage Standing Wave Ratio (VSWR)\***

VSWR is a measure of how efficiently radio-frequency power is transmitted from a power source, through a transmission line, into a load. In an ideal system, 100% of the energy is transmitted which corresponds to a VSWR of 1:1.

The PUCK-5 delivers superior performance across all bands with a VSWR of  $\leq 2:1$  over 95% of the band

\*Measured with 2m low loss cable

**Gain: Wi-Fi Antenna**

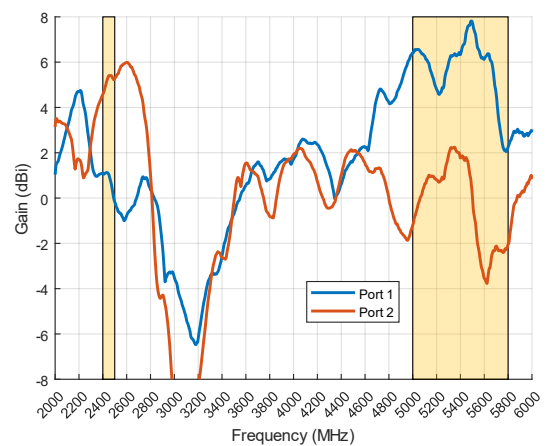

**Gain in dBi**

7.5 dBi is the peak gain across all bands from 2400-2500 & 5000 – 5800 MHz

Peak Gain @ different bands:	5.0 dBi @2400-2500MHz
Peak Gain @ different bands:	7.5 dBi @ 5000-5800MHz

**Radiation Patterns – Cellular**

**Azimuth (Top View): 690–960 MHz**

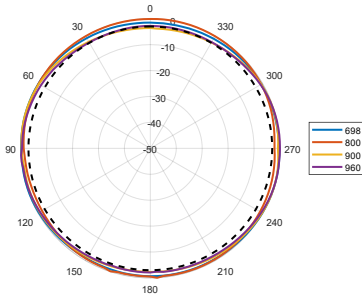

**Azimuth (Top View): 1710–2100 MHz**

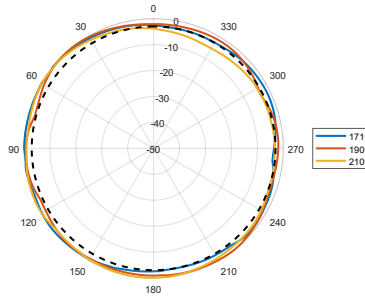

**Azimuth (Top View): 2300–2700 MHz**

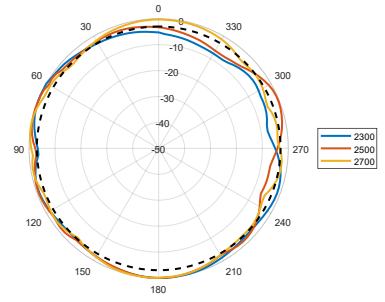

**Azimuth (Top View): 3400–3800 MHz**

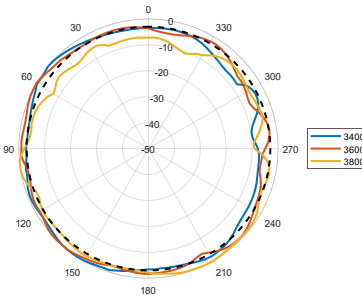

**Elevation1 (Side View): 690–960 MHz**

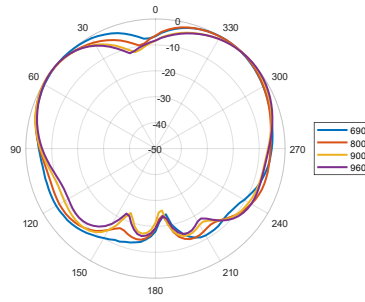

**Elevation1 (Side View): 1710–2100 MHz**

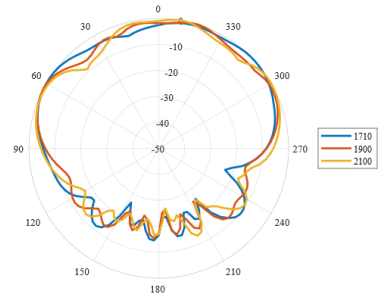

**Elevation1 (Side View): 2300–2700 MHz**

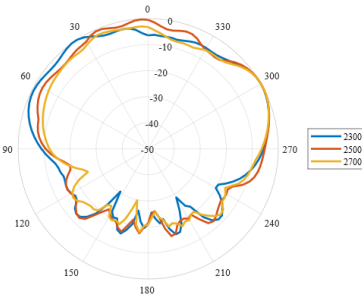

**Elevation1 (Side View): 3400–3800 MHz**

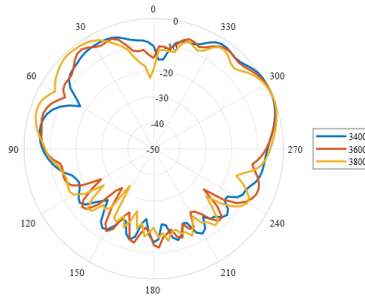

**Elevation2 (Side View): 690–960 MHz**

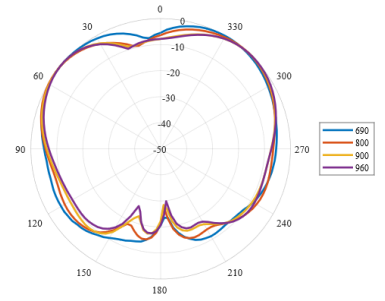

**Elevation2 (Side View): 1710–2100 MHz**

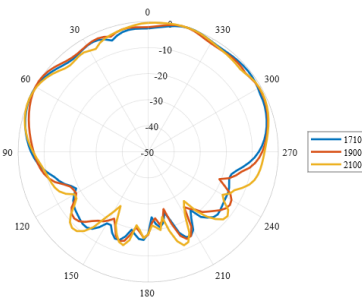

**Elevation2 (Side View): 2300–2700 MHz**

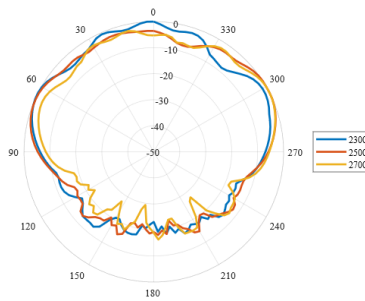

**Elevation2 (Side View): 3400-3800 MHz**

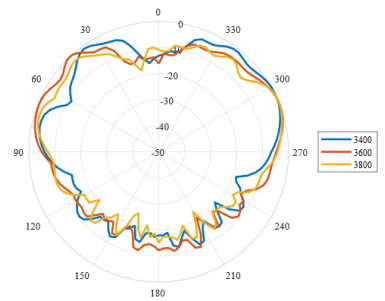

**Radiation Patterns – Wi-Fi**

Azimuth (Top View): 2400–2500 MHz

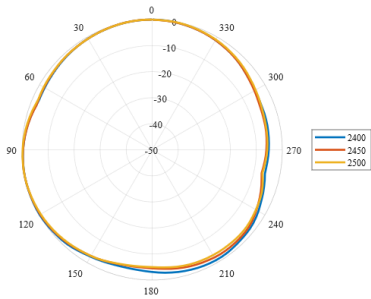

Azimuth (Top View): 5000–5400 MHz

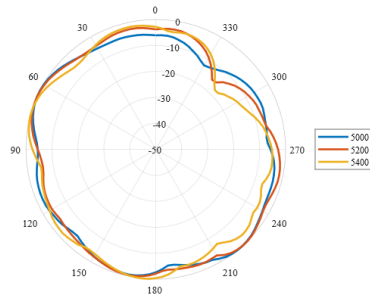

Azimuth (Top View): 5600–5800 MHz

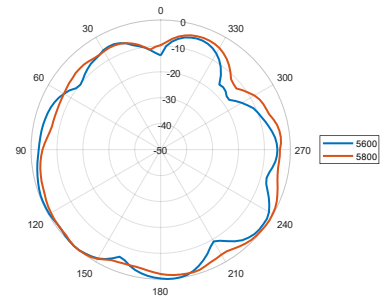

Elevation1 (Side View): 2400–2500 MHz

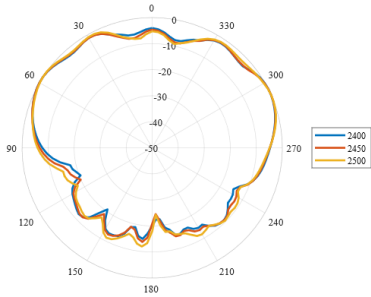

Elevation1 (Side View): 5000-5400 MHz

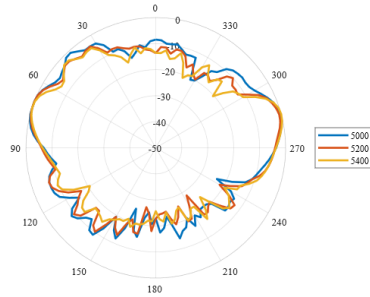

Elevation (Side View): 5600–5800 MHz

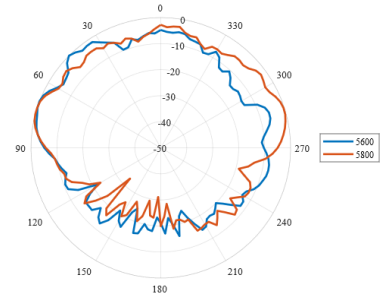

Elevation2 (Side View): 2400–2500 MHz

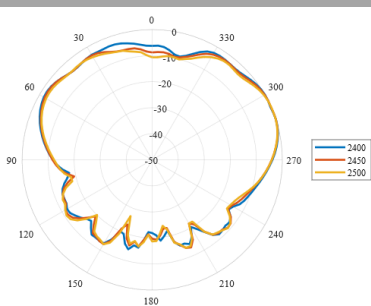

Elevation2 (Side View): 5000–5400 MHz

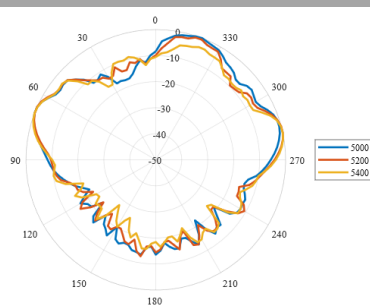

Elevation2 (Side View): 5600–5800 MHz

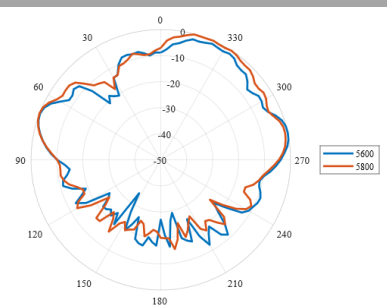

**Radiation Patterns – GPS**

XY Plane: 1561–1602 MHz

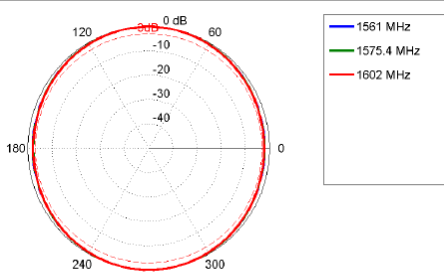

XZ Plane: 1561–1602 MHz

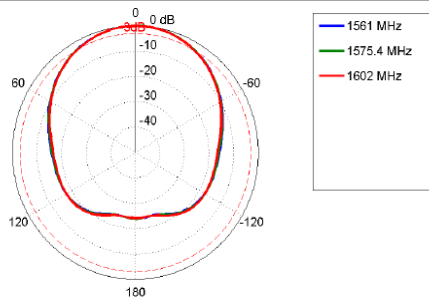

YZ Plane: 1561–1602 MHz

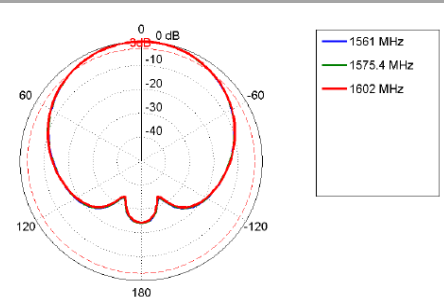

## Mounting Options

### Many Mounting Possibilities – included as standard

Poynting's new PUCK antenna range provides easy installation with the multiple mounting options. This includes as standard:

- Spigot Mount - two different lengths included (40mm & 80mm)
- Vertical Pole mount (inner & outer mounting for smaller and larger poles)
- Horizontal Pole Mount (e.g. marine rails)
- Magnetic Mount
- Surface Mount (Double Sided Tape)
- Wall Mount

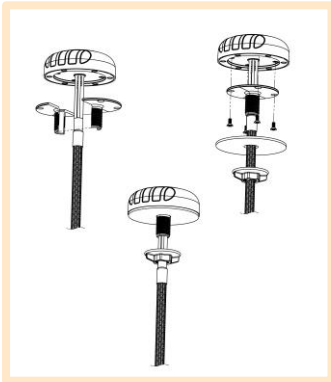

#### Spigot Mount

Removable 40mm & 80mm threaded spigot (included)

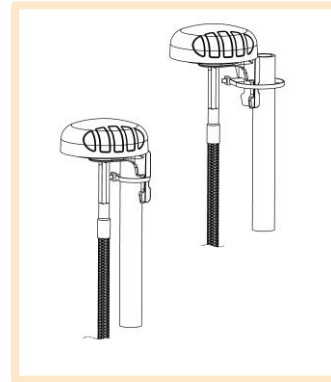

#### Vertical Pole Mount

Pole/Wall Mounting bracket (included)

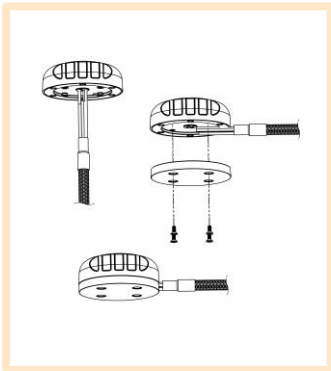

#### Magnetic Mount

Magnetic Base (included)  
For temporary and low mobility installations.

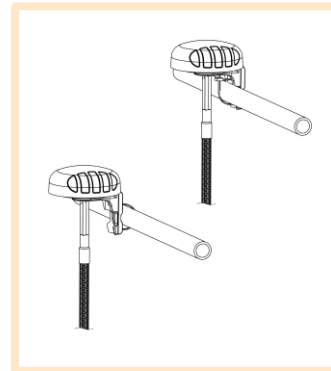

#### Horizontal Pole Mount

Pole/Wall Mounting bracket (included)

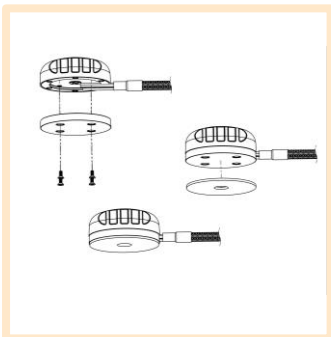

#### Surface Mount

Adhesive Surface Mounting (included) or can also be directly secured with longer M4 bolts (not included) to the female threaded inserts located in the antenna base

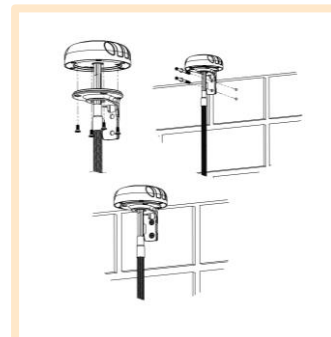

#### Wall Mount

Pole/Wall Mounting bracket (included)



---

### **Additional Accessories**

See accessories technical specifications on [www.poynting.tech](http://www.poynting.tech)

---

### **Contact Poynting**

#### **Poynting Antennas (Pty) Ltd - Head Office**

Unit 4, N1 Industrial Park  
Landmarks Avenue,  
Samrand, 0157  
South Africa

**Phone:** +27 (0) 12 657 0050

**E-mail:** sales@poynting.co.za

#### **Poynting Europe**

Regus Business Center Neue Messe Riem  
Kronstadter Straße 4  
81677 München  
Germany

**Phone:** +49 89 208026538

**E-mail:** sales-europe@poynting.tech