



*air*Fiber[®] 24

24 GHz Point-to-Point Radio

Models: AF-24, AF-24HD

USER GUIDE

Table of Contents

Chapter 1: Overview	1
Introduction	1
Package Contents	1
airFiber Configuration Interface System Requirements	1
Hardware Overview	2
Chapter 2: Installation	5
Link Planning	5
Installation Requirements	6
Installation Overview	6
Connecting Power over Ethernet	6
airFiber Configuration	7
Hardware Installation	9
Connecting the GPS Antenna	11
Connecting Ethernet	12
Alignment	13
Chapter 3: Navigation	21
Accessing the airFiber Configuration Interface	21
Navigating the Interface	22
Notifications	23
Product Verification	23
Chapter 4: Dashboard	25
Link Status	25
Statistics	26
Device Status	27
Ethernet Connection Status	27
Chapter 5: Wireless Tab	29
Basic Wireless Settings	29
Wireless Security	31
Advanced Wireless Settings	31
Chapter 6: Network Tab	33
Management Network Settings	33
Data Port Ethernet Settings	34
Ethernet Carrier Drop Settings	34

Chapter 7: Services Tab	37
Ping Watchdog.....	37
SNMP Agent.....	37
Telnet Server	38
NTP Client.....	38
Dynamic DNS	39
System Log.....	39
Device Discovery	39
Chapter 8: System Tab	41
Firmware Update.....	41
Device	42
Date Settings.....	42
System Accounts	42
Location	43
Device Maintenance.....	43
Chapter 9: Tools	45
Align Antenna.....	45
Discovery	46
Ping.....	46
Traceroute	46
airView.....	47
Log	49
Appendix A: Specifications	51
Appendix B: Safety Notices	55
Electrical Safety Information	55
Appendix C: Warranty	57
Limited Warranty	57
Appendix D: Compliance Information	59
Installer Compliance Responsibility	59
FCC	59
ISED Canada.....	59
RF Exposure Warning	59
CE Marking.....	59
RoHS/WEEE Compliance Statement.....	60
Appendix E: Declaration of Conformity	61
Appendix F: Contact Information	63
Ubiquiti Networks Support	63

Chapter 1: Overview

Introduction

Thank you for purchasing the Ubiquiti Networks® airFiber® 24 GHz Point-to-Point Radio. This User Guide is for use with the following models.

Model	Description	Operating Frequency*
AF-24	24 GHz Point-to-Point 1.4+ Gbps Radio	24.05 - 24.24 GHz
AF-24HD	24 GHz Full Duplex Point-to-Point 2 Gbps Radio	24.05 - 24.24 GHz

* Depends on Regulatory Region. Refer to **“Specifications” on page 41** for more information.

The same instructions apply to both models. This User Guide will refer to both models as the *airFiber AF-24* or *AF-24*. This User Guide provides installation instructions, explains how to set up an airFiber link, and shows how to access and use the airFiber Configuration Interface.

Package Contents



TERMS OF USE: Ubiquiti radio devices must be professionally installed. Shielded Ethernet cable and earth grounding must be used as conditions of product warranty. TOUGH Cable™ is designed for outdoor installations. It is the professional installer's responsibility to follow local country regulations, including operation within legal frequency channels, output power, and Dynamic Frequency Selection (DFS) requirements.

airFiber Configuration Interface System Requirements

- Microsoft Windows 7, Windows 8; Linux; or Mac OS X
- Java Runtime Environment 1.6 (or above)
- Web Browser: Mozilla Firefox, Apple Safari, Google Chrome, Microsoft Edge, or Microsoft Internet Explorer 11

Hardware Overview

AF-24

Side

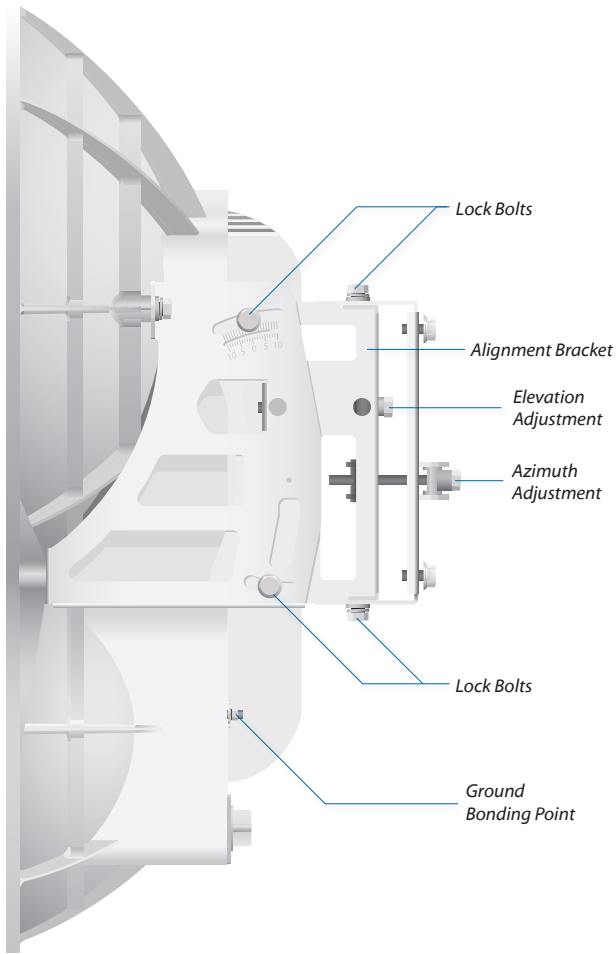

Back

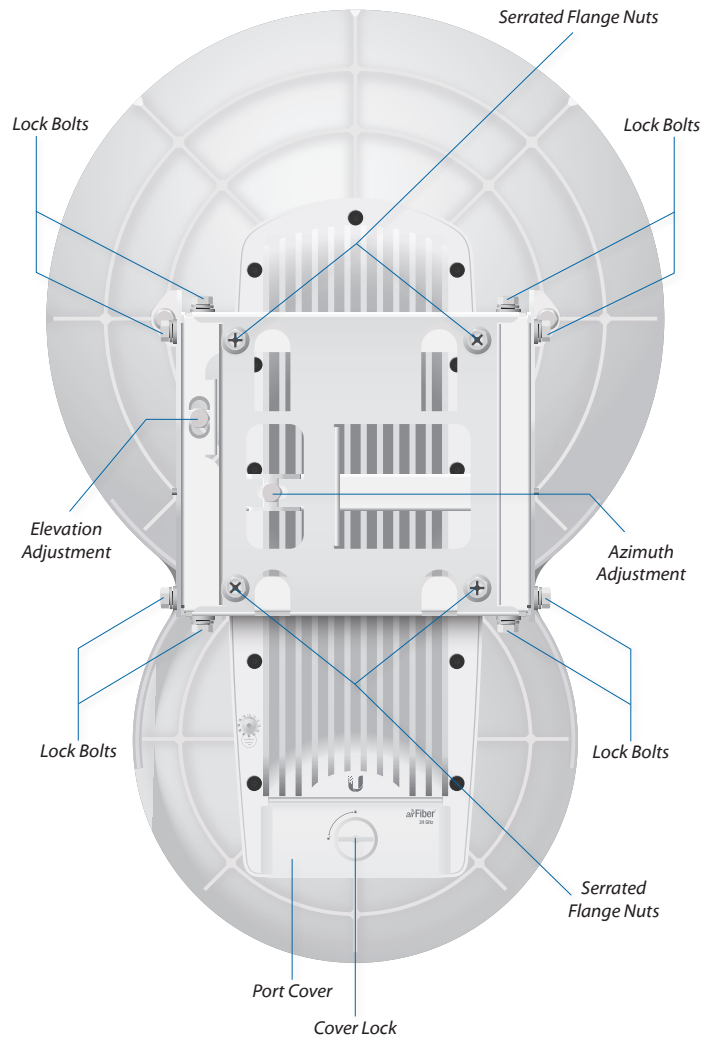

AF-24HD

Side

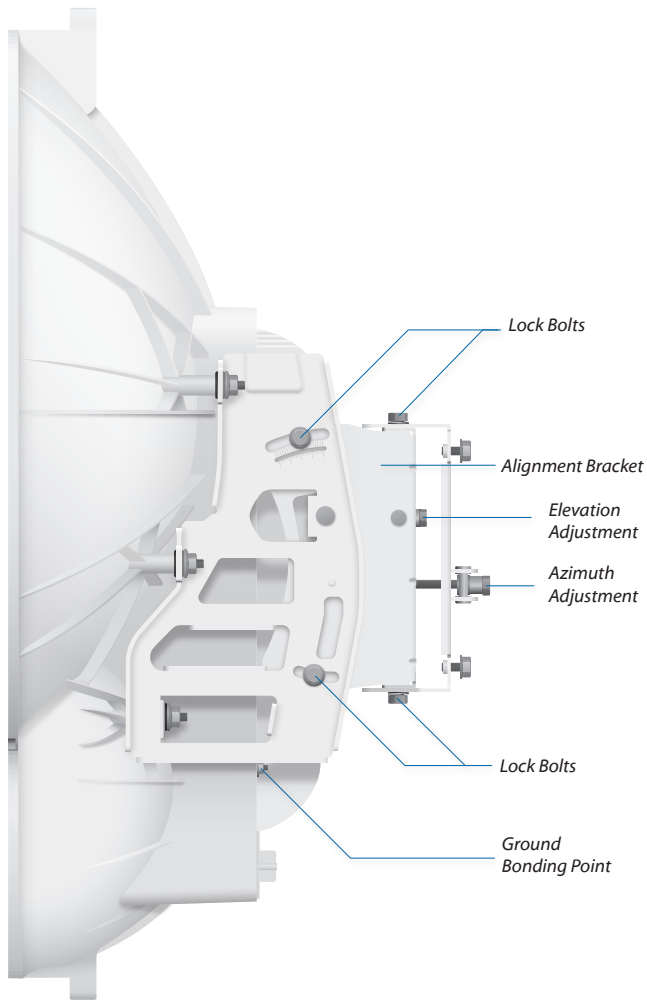

Back

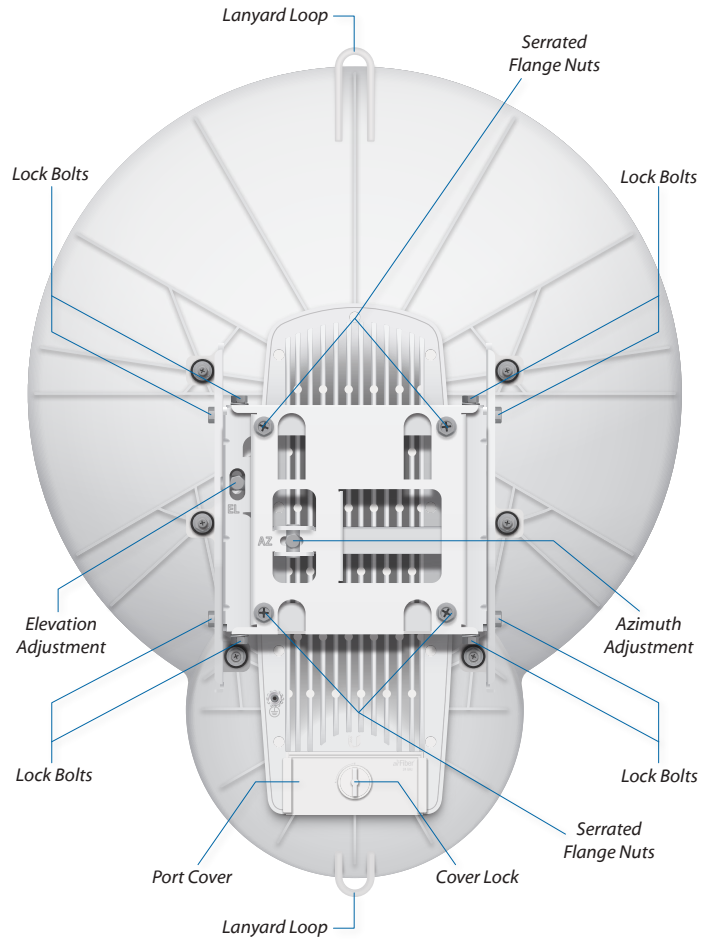

Interfaces

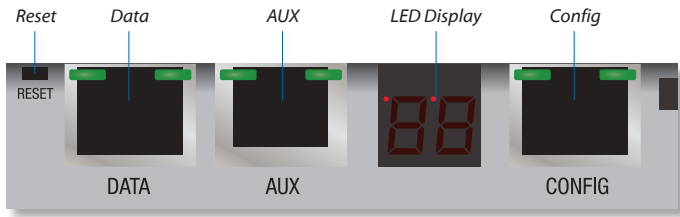

AF-24

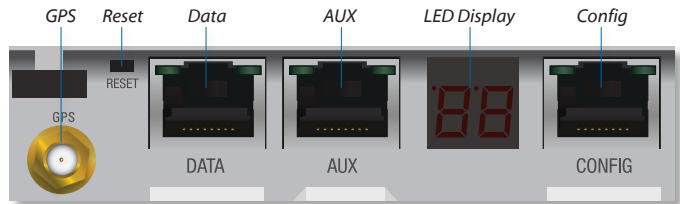

AF-24HD

Interface	Description
GPS	(Available only on AF-24HD.) Connect the <i>External GPS Antenna</i> to this SMA connector.
Reset	To reset to factory defaults, press and hold the Reset button for more than five seconds while the unit is powered on.
Data	10/100/1000 Mbps port handles all user traffic.
AUX	Port for audio tone aiming.
LED Display	Digital display used for power, status, and mode information.
Config	10/100 Mbps, secured port for configuration. By default, this is the only port that can monitor, configure, and/or update firmware.

LEDs

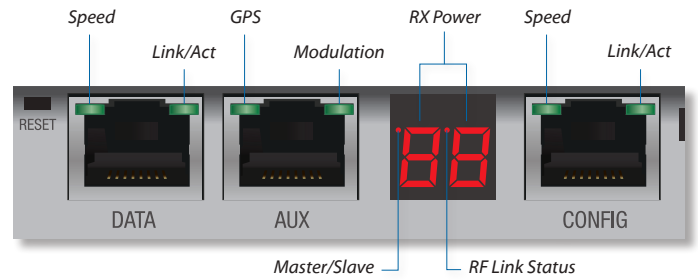

LED		State	Status
Data	Speed	Off	10/100 Mbps
		On	1000 Mbps
	Link/Act	Off	No Ethernet Link
		On	Ethernet Link Established
	Random Flashing	Ethernet Activity	
AUX	GPS	Off	No GPS Synchronization
		On	Operational (Strong Signal)
		Normal Flash*	Operational (Weak Signal)
	Modulation	Off	¼x or 1x (QPSK SISO)
		Short Flash*	2x (QPSK MIMO)
		Normal Flash*	4x (16QAM MIMO)
Long Flash*		6x (64QAM MIMO)	
	On	8x (256QAM MIMO)	
LED Display	RX Power (-dBm)	Number	Decodable RX Signal
		Flashing Number	Undecodable RX Signal
		□ L	Overload Condition
	Master/Slave	Off	Slave Mode
		On	Master Mode
	RF Link Status	Off	RF Off
		Short Flash*	Syncing
		Normal Flash*	Beaconing
		Long Flash*	Registering
	On	Operational	
Config	Speed	Off	10 Mbps
		On	100 Mbps
	Link/Act	Off	No Ethernet Link
		On	Ethernet Link Established
	Random Flashing	Ethernet Activity	

* Short Flash (1:3 on/off cycle)
 Normal Flash (1:1 on/off cycle)
 Long Flash (3:1 on/off cycle)

Chapter 2: Installation

Link Planning

Before you install the airFiber AF-24, there are a few items to consider:

- Humidity and rain
- Point-to-Point (PtP), daisy chain, or ring configuration
- Co-Location

Humidity and Rain

Consider the impact of humidity and rain on your link. Radio waves in the 24 GHz band encounter additional atmospheric attenuation beyond that which is expected in free space due to water absorption, including rain fade. A general guideline is an additional loss of 1 to 3 dB per kilometer. The amount of additional atmospheric attenuation will vary, depending on your specific installation environment (the world has a variety of rainfall zones).

Here is a hypothetical example: if your link is exposed to a 25 mm/hr (0.98 in/hr) rate of rainfall, it may have an additional loss of up to 4 dB/km (6.45 dB/mi).

The table below illustrates the estimated additional attenuation at various rainfall rates and distances. This information was derived from [FCC Office of Engineering and Technology Bulletin #70](#).

Estimated Additional Attenuation at Various Rain Rates and Distances

Distance	1.25 mm/hr (0.05 in/hr)	5 mm/hr (0.20 in/hr)	25 mm/hr (0.98 in/hr)
1 km (0.62 mi)	0.2 dB	0.7 dB	4 dB
2 km (1.2 mi)	0.4 dB	1.4 dB	8 dB
3 km (1.9 mi)	0.6 dB	2.1 dB	12 dB
4 km (2.5 mi)	0.8 dB	2.8 dB	16 dB
5 km (3.1 mi)	1 dB	3.5 dB	20 dB

There are a variety of software programs available to help calculate rain attenuation. For more information about rain attenuation and rainfall zones, here are a couple of resources:

- The rain attenuation model described in ITU-R Recommendation P.530, *Propagation data and prediction methods required for the design of terrestrial line-of-sight systems*, which is available at: www.itu.int/rec/R-REC-P.530/en
- The rainfall zones described in ITU-R Recommendation P.837, *Characteristics of precipitation for propagation modelling*, which is available at: <http://www.itu.int/rec/R-REC-P.837/en>

Configuration

There are three typical configurations:

- **PtP backhaul** Uses two airFiber radios, one configured as *Master* and the other configured as *Slave*.



Point-to-Point Backhaul

- **Daisy chain** Uses multiple airFiber radios to extend the distance of a link, like a relay from point to point to point. The airFiber radios in the same node must use the same *Wireless Mode (Master or Slave)*.

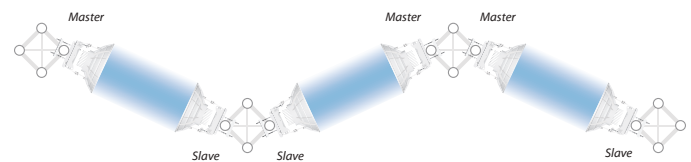

Daisy Chain Configuration

- **Ring** Uses multiple airFiber radios to form redundant paths. If one link goes down, the other links have an alternate route available. For each link, configure one airFiber radio as *Master*, and configure the other as *Slave*.

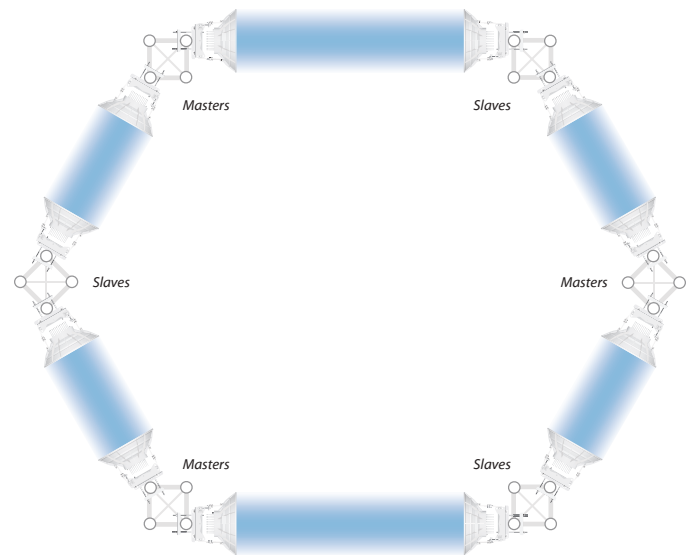

Ring Configuration

Co-Location

In most cases, co-location interference is not a concern because the beamwidth is narrow. You can co-locate multiple airFiber radios if they are pointed in different directions. Co-located airFiber radios must use the same *Wireless Mode (Master or Slave)*. Back-to-back airFiber radios can use the same frequency. We recommend that you use different frequencies for adjacent airFiber radios; however, this is not a strict requirement.

Installation Requirements

- 17 mm (11/16") wrench
- 13 mm (1/2") socket wrench or driver
- Clear line of sight between airFiber radios
- Clear view of the sky for proper GPS operation
- Mounting location with $< 0.5^\circ$ displacement due to twist and sway under wind loading
- Mounting point:
 - At least 1 m (3.28 ft) below the highest point on the structure
 - For tower installations, at least 3 m (9.84 ft) below the top of the tower
- Ground wires – min. 8 AWG (10 mm²) and max. length: 1 m (3.28 ft). As a safety precaution, ground the airFiber radios to grounded masts, poles, towers, or grounding bars.

! **WARNING: Failure to properly ground your airFiber units will void your warranty.**

- (Recommended) 2 Outdoor GigE PoE surge protectors

📄 **Note:** For guidelines about grounding and lightning protection, follow your local electrical regulatory codes.

- Outdoor, shielded Category 5e (or above) cabling and shielded RJ-45 connectors should be used for all wired Ethernet connections. Category 6 is required for installations with long cable runs (up to 100 m).

We recommend that you protect your networks from harmful outdoor environments and destructive ESD events with industrial-grade shielded Ethernet cable from Ubiquiti Networks. For more details, visit www.ubnt.com/toughcable

Installation Overview

We recommend that you configure your paired airFiber radios before mounting. Below is an overview of the installation with specific details on the following pages:

- Connect Power over Ethernet to the *Data* port, and connect an Ethernet cable between your computer and the *Config* port.
- Configure the device settings in the airFiber Configuration Interface.
- Once configuration is complete, disconnect the cables to move the airFiber radios.
- Reconnect at the site.
- After you have mounted the airFiber radios, establish and optimize the RF link.

📄 **Note:** Throughout the rest of this chapter, only the AF-24 is shown in illustrations (the AF-24HD is similar), unless necessary to avoid confusion.

Connecting Power over Ethernet

1. Turn the *Cover Lock* to the *Unlocked*  icon. Slide the *Port Cover* down to remove it.

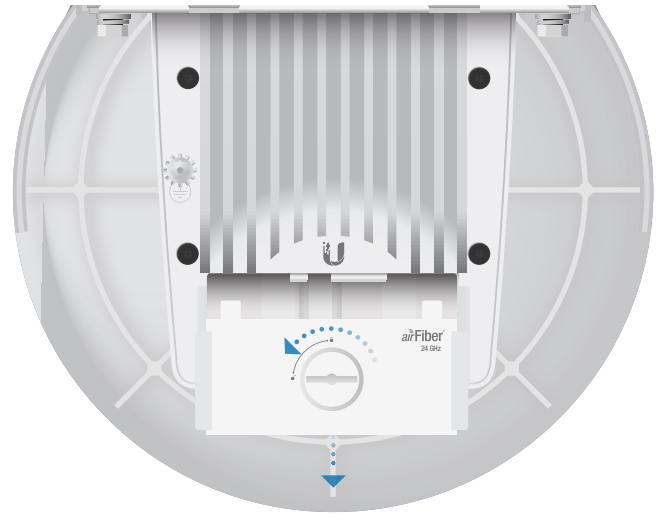

2. Connect an Ethernet cable to the *Data* port.

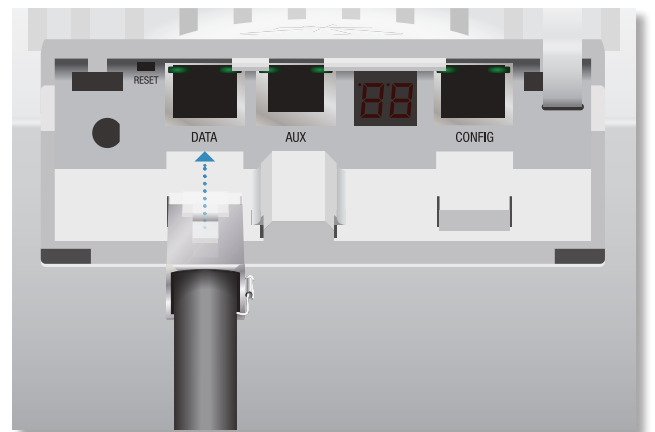

3. Connect the other end of the Ethernet cable from the *Data* port to the Ethernet port labeled **POE** on the PoE Adapter.

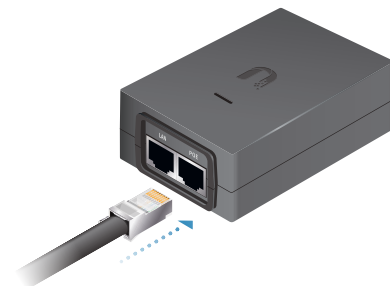

4. Connect the *Power Cord* to the power port on the *PoE Adapter*. Connect the other end of the *Power Cord* to a power source.

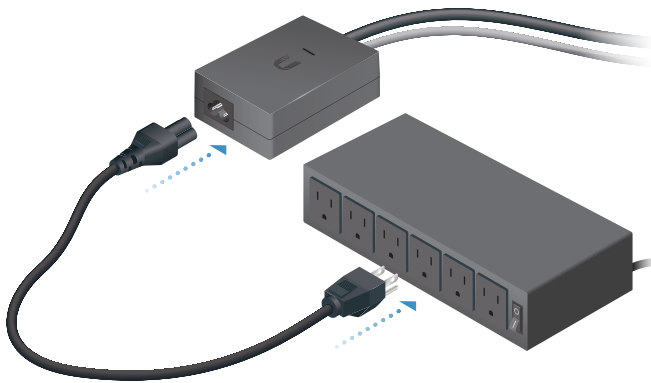

airFiber Configuration

The instructions in this section explain how to access the airFiber Configuration Interface and configure the following settings:

- **Wireless Mode** Configure one airFiber AF-24 as the *Master* and the other as the *Slave*.
- **Duplex** The airFiber AF-24 supports both half-duplex and full-duplex operation. Half-duplex operation provides more frequency planning options at the cost of higher latency and throughput. Full-duplex operation provides the highest throughput and lowest latency; however, you have fewer frequency management options.
 - **Half Duplex (default)** The *TX* and *RX* Frequencies can be the same or different to suit local interference.

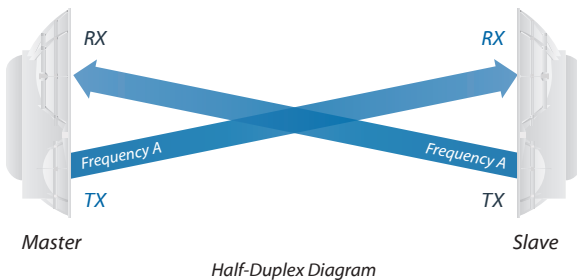

- **Full Duplex** The *TX* and *RX* Frequencies should be different.

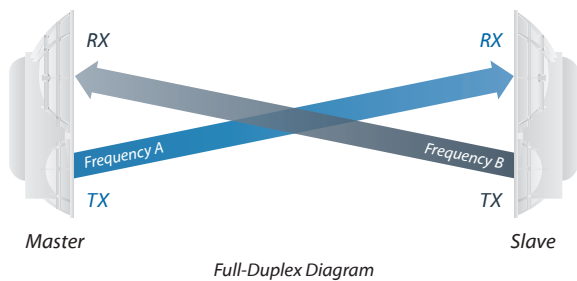

- **TX and RX Frequencies** The *TX* Frequency on the Master must match the *RX* Frequency on the Slave, and vice versa.

1. Connect an Ethernet cable from your computer to the *Config* port on the airFiber AF-24.

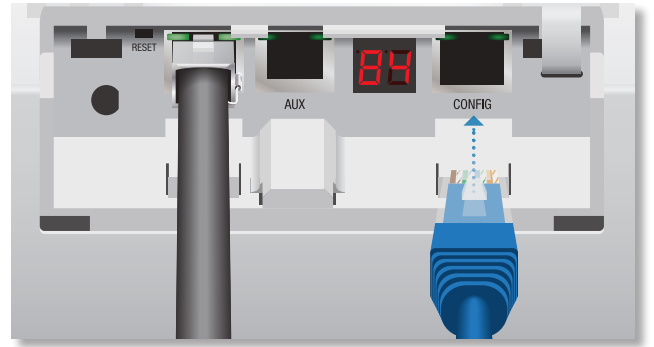

2. Configure the Ethernet adapter on your computer with a static IP address on the 192.168.1.x subnet (for example, 192.168.1.100).
3. Launch your web browser. Type **http://192.168.1.20** in the address field and press **enter** (PC) or **return** (Mac).

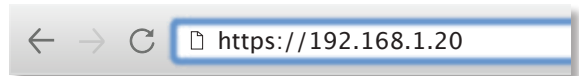

4. The login screen will appear. Enter **ubnt** in the *Username* and *Password* fields. Select your *Country* and *Language*. You must agree to the *Terms of Use* to use the product. Click **Login**.

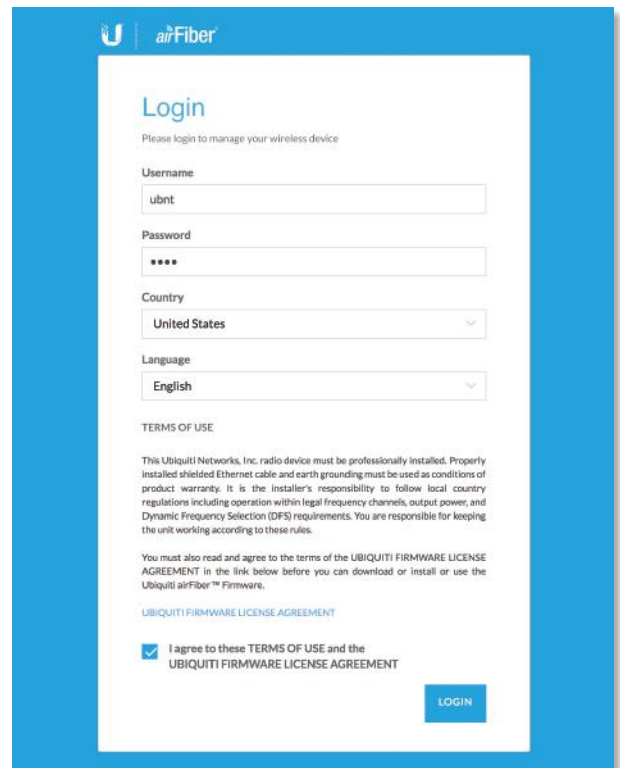

Note: U.S. product versions are locked to the U.S. Country Code to ensure compliance with FCC regulations.

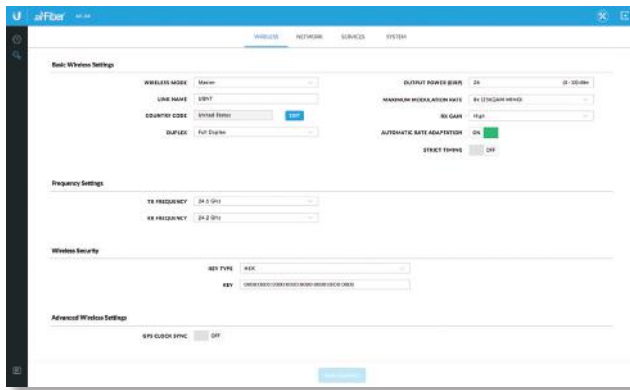
5. Click the **Wireless** tab.6. Enter the *Basic Wireless Settings*:

- For one airFiber AF-24, select **Master** from the *Wireless Mode* drop-down. For the other airFiber AF-24, keep the default, *Slave*.
- Enter a name in the *Link Name* field. This should be the same on both the Master and the Slave.
- For the *Duplex* drop-down:
 - **Half Duplex** The default mode. The *TX* and *RX Frequencies* can be the same or different to suit local interference.
 - **Full Duplex** The *TX* and *RX Frequencies* should be different.
- Select a *TX Frequency*. This must match the *RX Frequency* on your other airFiber AF-24.
- Select a *RX Frequency*. This must match the *TX Frequency* of your other airFiber AF-24.
- If needed, change the *Output Power*, *Maximum Modulation Rate*, and/or *RX Gain* settings.

7. Configure the *Wireless Security*:

- Select the *AES Key Type*, **HEX** or **ASCII**.
 - For the *Key* field:
 - **HEX** Enter 16 bytes (eight, 16-bit HEX values: 0-9, A-F, or a-f). You can omit zeroes and use colons, similar to the IPv6 format.
- Note:** The airFiber Configuration Interface supports IPv6 formats excluding dotted quad and “::” (double-colon) notation.
- **ASCII** Enter a combination of alphanumeric characters (0-9, A-Z, or a-z).

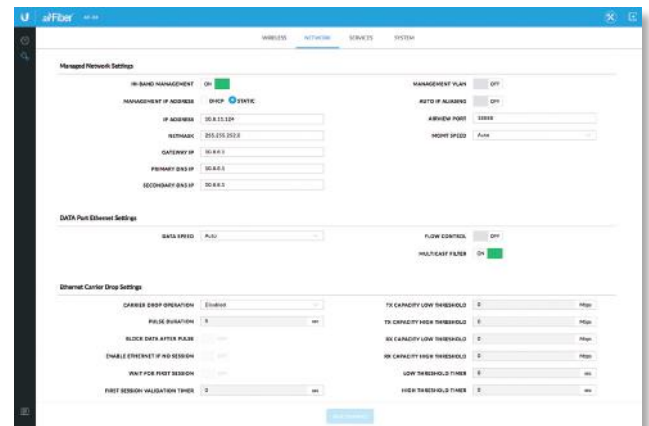
8. Click **Change** and then click **Apply**.9. *In-Band Management* is enabled by default, so each airFiber radio must have a unique *IP Address*. (If the airFiber radios use the same *IP Address*, then you may lose access to the airFiber radios via the *Data* ports.) To change the network settings:a. Click the **Network** tab.

- Change the *IP Address*, *Netmask*, and other settings to make them compatible with your network.
- Click **Change** and then click **Apply**.

Repeat the instructions in the *airFiber Configuration* section on your other airFiber radio. After you have configured the airFiber radios, disconnect them and move them to your installation site.

Hardware Installation

To install the airFiber AF-24:

1. Insert the four *Carriage Bolts* into the *Pole Mount Bracket*.

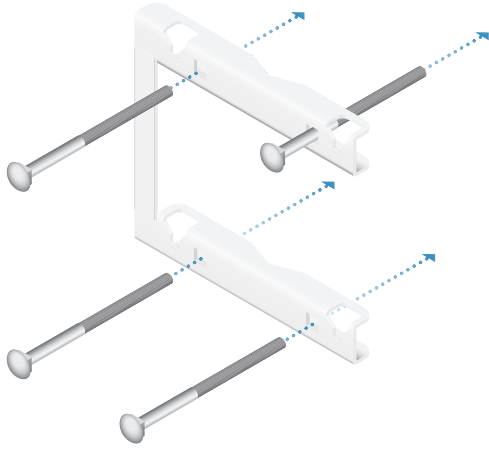

2. Attach the *Pole Mount Bracket* to a pole.

 **Note:** The mounting assembly can accommodate a \varnothing 51 - 101 mm (2.0" - 4.0") pole.

- a. Orient the *Pole Mount Bracket* around the pole so it is aimed in the direction of the other airFiber AF-24.
- b. Insert the *Carriage Bolts* into the *Pole Clamps*.
- c. Secure the clamps with the *Flat Washers*, *Split Lock Washers*, and *Hex Nuts*.

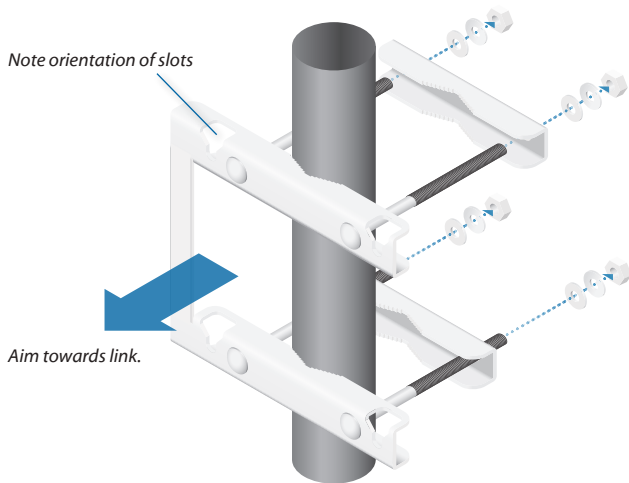

3. Loosen, but do NOT remove the eight *Lock Bolts* located on the *Alignment Bracket*.

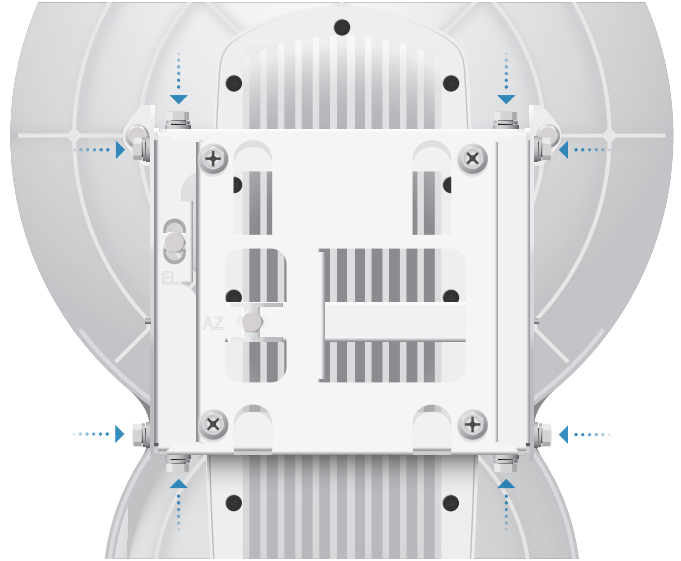

4. Ensure that there is a 6 mm (0.24 in) gap between the head of each *Serrated Flange Screw* and the *Alignment Bracket*.

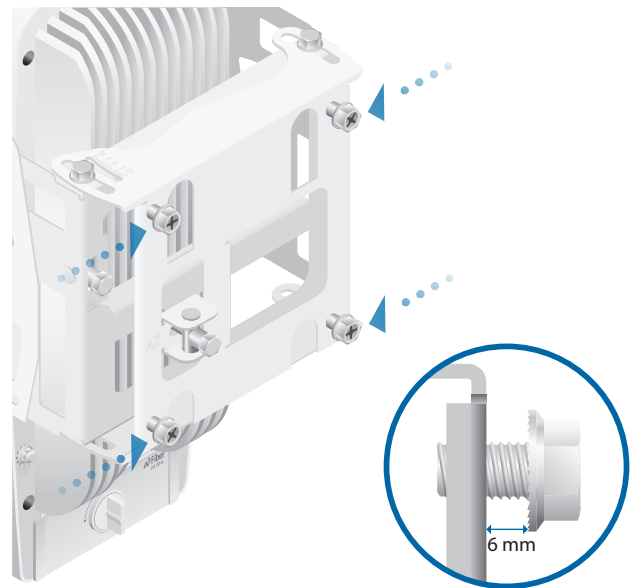

- Lift the airFiber AF-24 and align the four *Serrated Flange Screws* with the slots on the *Pole Mount Bracket*. Seat the screws in the slots. Securely tighten the screws.

! **WARNING:** To prevent injury, ensure that all four screws are seated and fully tightened.

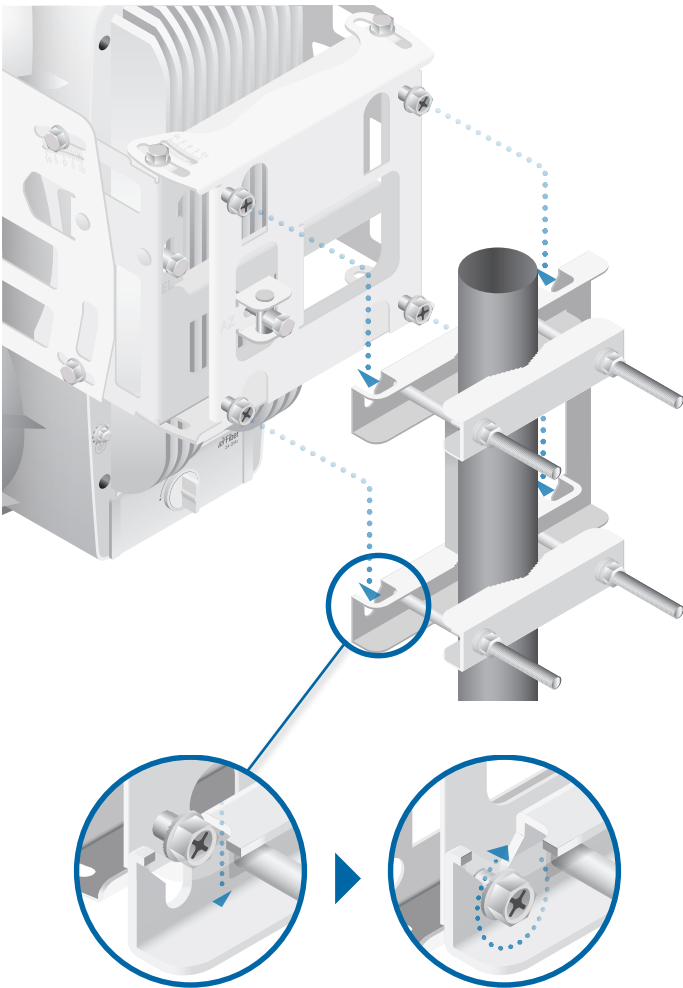

Grounding

To attach a ground wire:

- Remove the nut from the *Ground Bonding Point*.

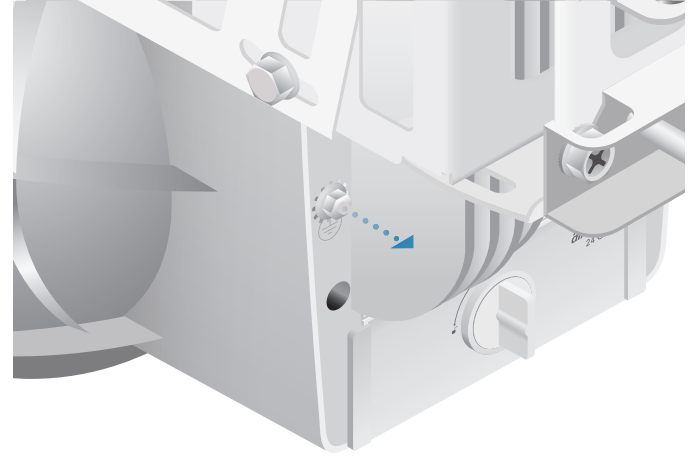

- Attach a ground wire (min. 8 AWG or 10 mm²) to the lug and replace the nut to secure the wire.

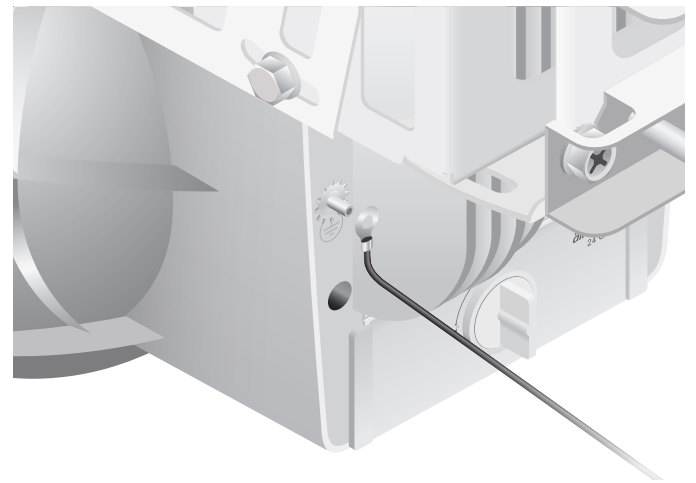

- Secure the other end of the ground wire to a grounded mast, pole, tower, or grounding bar.

! **WARNING:** Failure to properly ground your airFiber units will void your warranty.

📄 **Note:** The grounding wire should be as short as possible and no longer than 1 meter (3.28 ft) in length.

Connecting the GPS Antenna

 **Note:** This section applies to the AF-24HD only.

Locate a mounting point for the *External GPS Antenna* that has a clear view to the sky, and is above and as far away as possible from the AF-24HD

1. Attach the *GPS Antenna Mount* to a pole using the included *Metal Strap*, or attach it to a wall using the appropriate fasteners (not included).

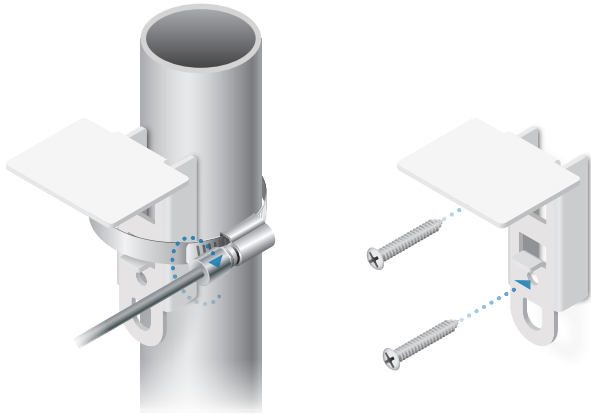

2. Place the magnetic *External GPS Antenna* on the mount.



3. Secure the cable of the *External GPS Antenna* to the mount with a *Cable Tie*.



4. Turn the *Cover Lock* counterclockwise to the *Unlocked* icon. Slide the *Port Cover* down to remove it.

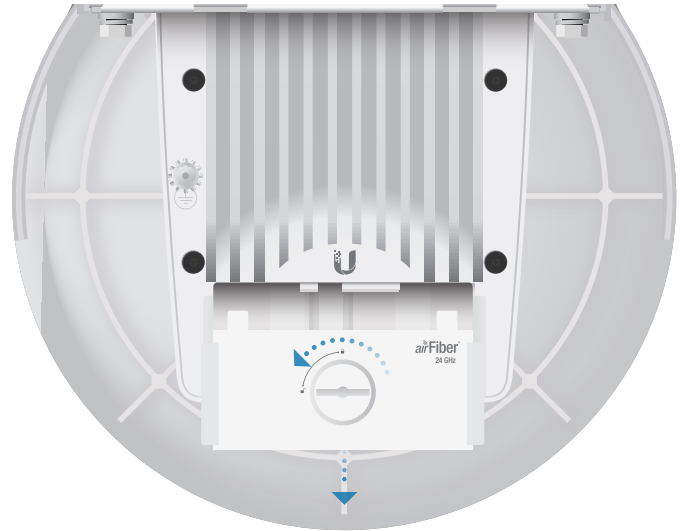

5. Connect the *External GPS Antenna* to the *GPS SMA* connector.



Connecting Ethernet

1. Connect a TOUGH Cable or other outdoor, shielded CAT5e/6 cable to the *Data* port.

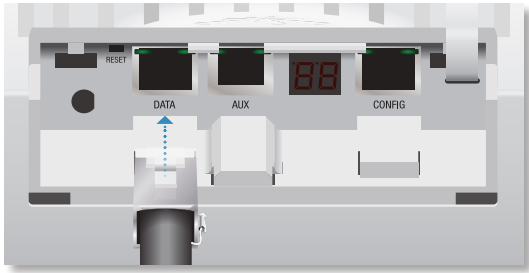

2. Create a strain relief for the Ethernet cable by feeding a cable tie through the tie slot under the cable. Then wrap the cable tie around the cable and tighten.

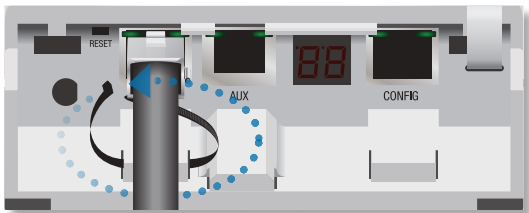

3. Connect the Ethernet cable from the *Data* port to the **POE** port on the *PoE Adapter*.

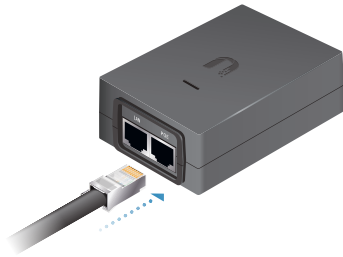

4. Connect an Ethernet cable from your LAN to the **LAN** port on the *PoE Adapter*.

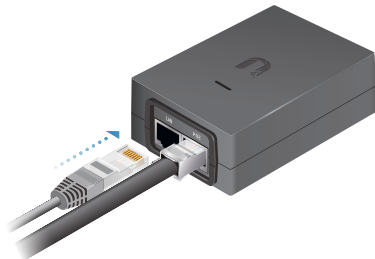

5. Connect the *Power Cord* to the *PoE Adapter*, and then plug the *Power Cord* into a power outlet.

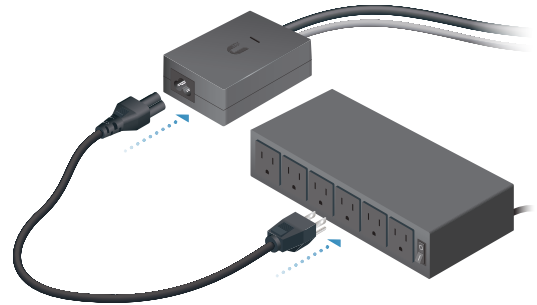

Note: For added protection, we recommend installing two GigE PoE surge protectors. Install the first surge protector within one meter of the airFiber *Data* port, and install the second surge protector at the ingress point of the location housing the wired network equipment.

Below is a diagram of a finished installation with recommended surge protectors installed.

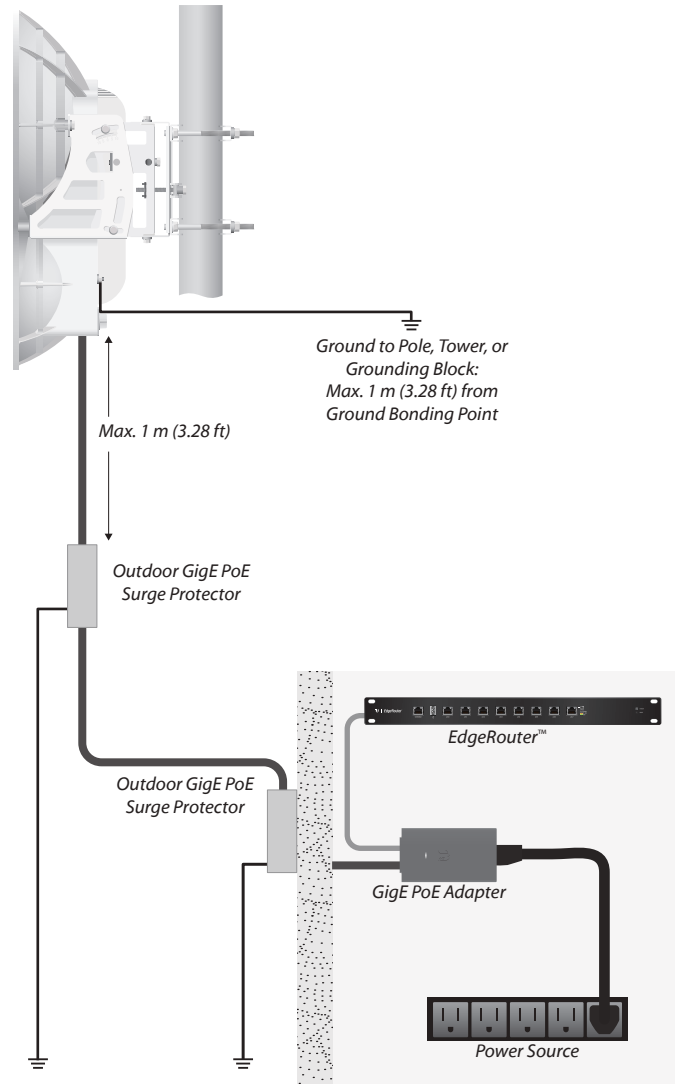

Alignment

Tips

- Fine-tuning is best achieved by a pair of installers with a dedicated, two-way communication link: one installer makes adjustments on one airFiber radio while the other installer reports the received signal level at the other airFiber radio. Fine-tuning (see [“Fine-Tuning the Link” on page 15](#)) is necessary because the main lobe of the receiver is narrower than that of the transmitter, in both azimuth and elevation.
- To accurately align the airFiber radios for best performance, you **MUST** align only one end of the link at a time.
- For more convenient alignment, you may consider using long-range scopes (not included) temporarily attached to your airFiber radios.
- You may need to use additional hardware to compensate for issues such as the improper orientation of a mounting pole or significant elevation differences between the airFiber radios.

Determining the Received Signal Level

There are three ways to determine the received signal level:

- LED Display (See the following section, *Using the LED Display*.)
- airFiber Configuration Interface (See [“Using the airFiber Configuration Interface” on page 15](#).)
- Audio tone (Optional equipment required. See [“Using the Audio Tone” on page 18](#).)

Using the LED Display

Establishing a Preliminary Link

Adjust the positions of the *Master* and the *Slave* to establish a preliminary link. This requires the *Master* and *Slave* to be within a few degrees of the line of sight between the airFiber radios.

 **Note:** The *Master* must be aimed first at the *Slave* because the *Slave* does not transmit any RF signal until it detects transmissions from the *Master*.

1. For the *Master* and *Slave*, ensure the eight *Lock Bolts* on the *Alignment Bracket* are sufficiently loose by spinning each washer by hand.

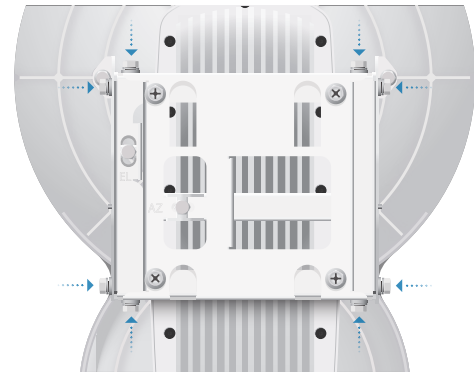

 **WARNING:** All *Lock Bolts* **MUST** be loose to avoid damage to the airFiber housing.

2. For the *Master* and *Slave*, ensure the *Azimuth (AZ)* and *Elevation (EL) Adjustment Bolts* are in the middle of their adjustment ranges.

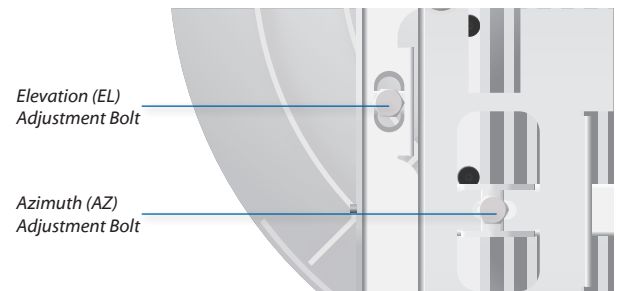

3. **Master** Aim the *Master* at the *Slave*. If necessary, adjust the *Master's* position on the pole:
 - a. Loosen the *Hex Nuts*.
 - b. Adjust the *Pole Mount Bracket and Pole Clamps*.
 - c. Tighten the *Hex Nuts*.

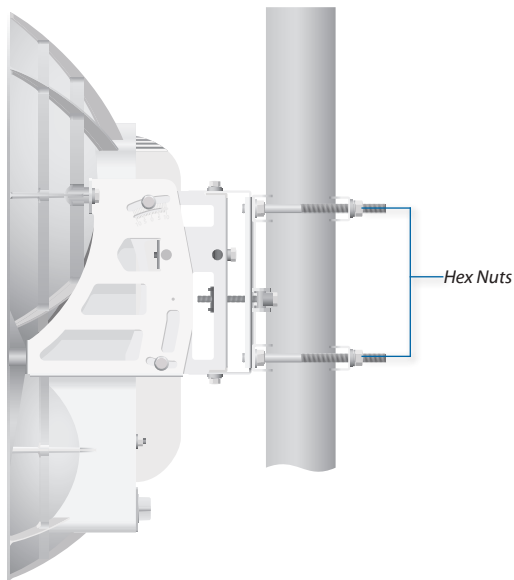

4. **Slave** Aim the *Slave* at the *Master* to achieve the strongest received signal level on the *Slave's* numeric LED Display, which is located next to the *Config* port. If necessary, adjust the *Slave's* position on the pole.

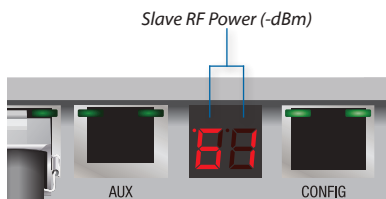

- Note:** Values on the LED Display are displayed in negative (-) dBm. For example, 61 represents a received signal level of -61 dBm, which is stronger than -72 dBm.

5. **Master** Adjust the azimuth and elevation of the *Master* until the strongest received signal level is displayed on the LED Display of the *Master*.
 - a. Sweep the *Azimuth (AZ) Adjustment Bolt* of the *Master* through its adjustment range.

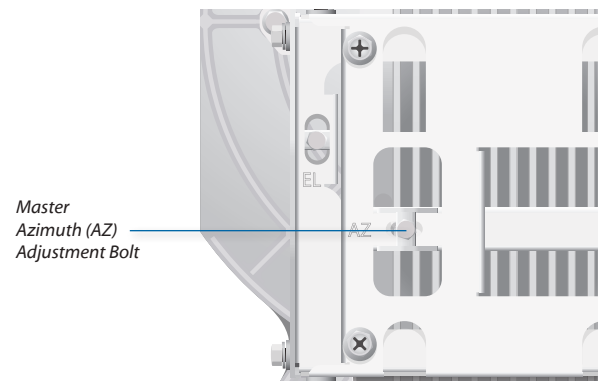

- b. Sweep the *Elevation (EL) Adjustment Bolt* of the *Master* through its adjustment range.

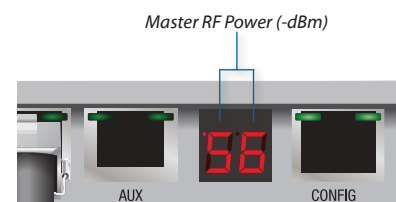
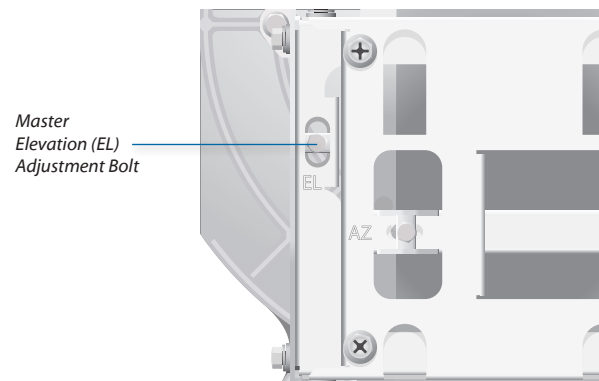

- Note:** If the LED Display indicates an overload condition **OL**, see **"RX Gain" on page 30** for more details about *RX Gain* and overload condition.

Fine-Tuning the Link

The *Azimuth (AZ)* and *Elevation (EL) Adjustment Bolts* of the *Alignment Bracket* adjust the azimuth and elevation within a range of $\pm 10^\circ$. For accurate alignment, make adjustments on one end of the link while the other installer reports the received signal level at the other end of the link. Do NOT make simultaneous adjustments on the *Master* and *Slave*.

1. **Slave** Adjust the azimuth and elevation of the *Slave* until the other installer sees the strongest received signal level displayed on the LED Display of the *Master*.
2. **Master** Adjust the azimuth and elevation of the *Master* until the other installer sees the strongest received signal level displayed on the LED Display of the *Slave*.
3. Repeat steps 1 and 2 until you achieve a symmetric link, with the received signal levels within 1 dB of each other. This ensures the best possible data rate between the airFiber radios.
4. Lock the alignment on both airFiber radios by tightening all eight *Lock Bolts* on the *Alignment Bracket*.
5. Observe the LED Display on each airFiber AF-24 to ensure that the value remains constant while tightening the *Lock Bolts*. If the LED value changes during the locking process, loosen the *Lock Bolts*, finalize the alignment of each airFiber AF-24 again, and retighten the *Lock Bolts*.
6. For each airFiber AF-24, attach the *Port Cover* and turn the *Cover Lock* to the *Locked*  icon.



Using the airFiber Configuration Interface Before You Begin

Access the airFiber Configuration Interface:

1. Make sure that your computer that is connected to the *Config* port on the airFiber AF-24.
2. Configure the Ethernet adapter on your computer with a static IP address on the 192.168.1.x subnet (for example, 192.168.1.100).
3. Launch your web browser. Type **http://192.168.1.20** in the address field and press **enter** (PC) or **return** (Mac).

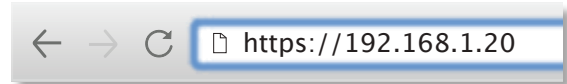

4. The login screen will appear. Enter **ubnt** in the *Username* and *Password* fields, and click **Login**.

 **Note:** U.S. product versions are locked to the U.S. Country Code to ensure compliance with FCC regulations.

5. The *Dashboard* of the airFiber Configuration Interface appears. Click the **Tools**  drop-down list at the top right corner of the page.
6. Click **Alignment**. You will use the *Align Antenna* tool to point and optimize the antenna in the direction of maximum link signal. (The *Antenna Alignment* window is designed to refresh every 250 milliseconds. See **“Align Antenna” on page 45** for more details.)

- The *Antenna Alignment* window appears, displaying the *Signal Strengths* for both airFiber radios. The *Chain Signal Strength* bar graphs display the *Signal Strengths* for the airFiber AF-24 you have accessed, while the *Remote Signal Strength* bar graphs display the *Signal Strengths* for the other airFiber AF-24.

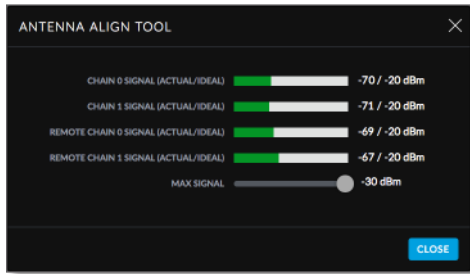

Establishing a Preliminary Link

Adjust the positions of the *Master* and the *Slave* to establish a preliminary link. This requires the *Master* and *Slave* to be within a few degrees of the line of sight between the airFiber radios.

Note: The *Master* must be aimed first at the *Slave* because the *Slave* does not transmit any RF signal until it detects transmissions from the *Master*.

- For the *Master* and *Slave*, ensure the eight *Lock Bolts* on the *Alignment Bracket* are sufficiently loose by spinning each washer by hand.

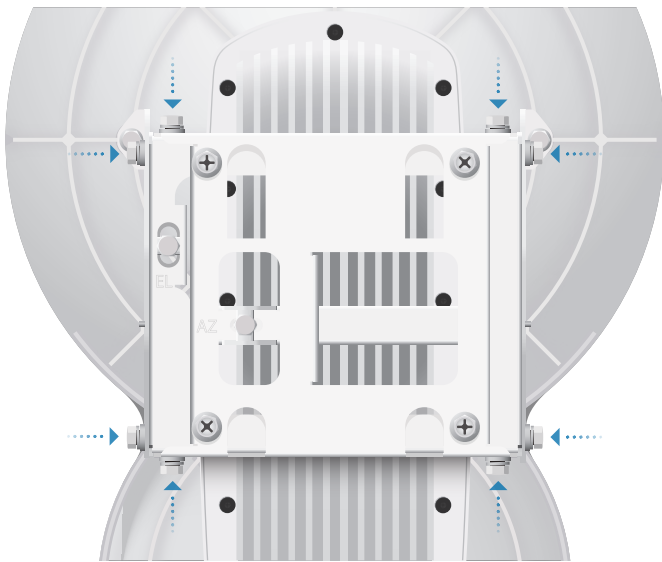

WARNING: All *Lock Bolts* MUST be loose to avoid damage to the airFiber housing.

- For the *Master* and *Slave*, ensure the *Azimuth (AZ)* and *Elevation (EL)* Adjustment Bolts are in the middle of their adjustment ranges.



- Master** Aim the *Master* at the *Slave*. If necessary, adjust the *Master's* position on the pole:
 - Loosen the *Hex Nuts*.
 - Adjust the *Pole Mount Bracket* and *Pole Clamps*.
 - Tighten the *Hex Nuts*.

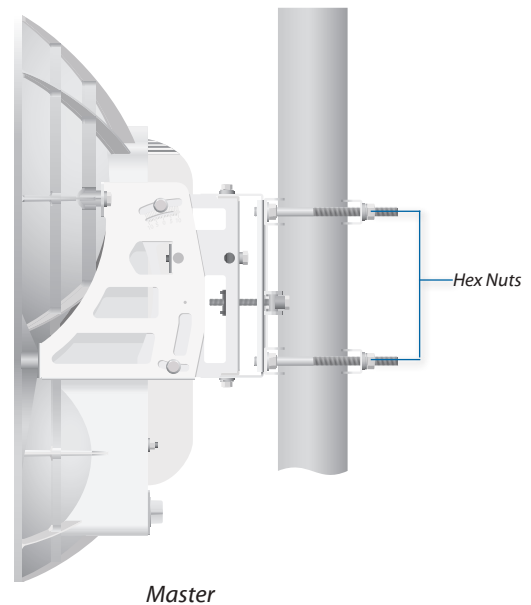

- Slave** Aim the *Slave* at the *Master* to achieve the strongest *Signal Strengths* for the *Slave*. If necessary, adjust the *Slave's* position on the pole.

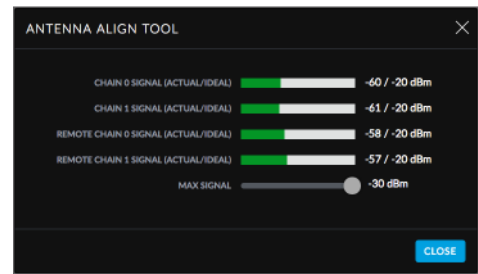

Note: The *Signal Strength* bar graphs display the absolute power level (in dBm) of the received signal for each chain. Lower values indicate stronger received signal levels.

5. **Master** Adjust the azimuth and elevation of the *Master* until the strongest *Signal Strengths* are displayed for the *Master*.
 - a. Sweep the *Azimuth (AZ) Adjustment Bolt* of the *Master* through its adjustment range.

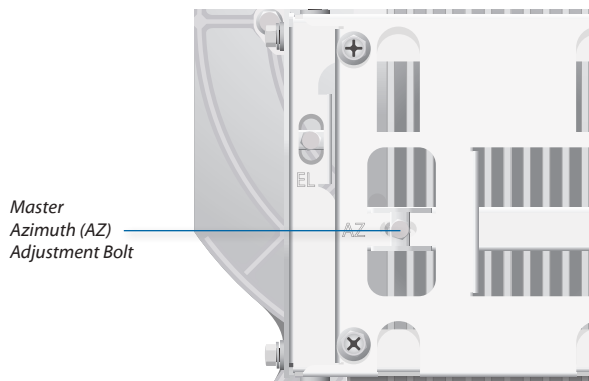

- b. Sweep the *Elevation (EL) Adjustment Bolt* of the *Master* through its adjustment range.

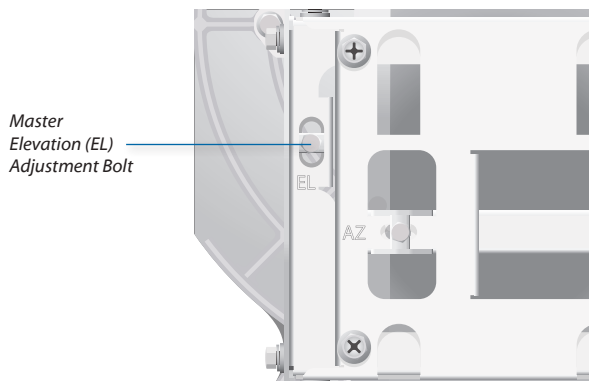

Fine-Tuning the Link

The *Azimuth (AZ)* and *Elevation (EL) Adjustment Bolts* of the *Alignment Bracket* adjust the azimuth and elevation within a range of $\pm 10^\circ$. For accurate alignment, make adjustments on one end of the link using the *Signal Strengths* for the airFiber radio at the other end of the link. Do NOT make simultaneous adjustments on the *Master* and *Slave*.

1. **Slave** Adjust the azimuth and elevation of the *Slave* until the other installer sees the strongest *Signal Strengths* for the *Master*.
2. **Master** Adjust the azimuth and elevation of the *Master* until the other installer sees the strongest *Signal Strengths* for the *Slave*.
3. Repeat steps 1 and 2 until you achieve a symmetric link, with the *Signal Strengths* within 1 dB of each other. This ensures the best possible data rate between the airFiber radios.
4. Lock the alignment on both airFiber radios by tightening all eight *Lock Bolts* on the *Alignment Bracket*.

Observe the *Antenna Alignment* window to ensure that the values remain constant while tightening the *Lock Bolts*. If the values change during the locking process, loosen the *Lock Bolts*, finalize the alignment of each airFiber AF-24 again, and retighten the *Lock Bolts*.

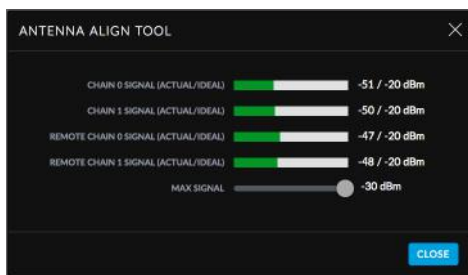

Note: If the *Antenna Alignment* window displays “Overload” to indicate overload condition, see **“RX Gain” on page 30** for more details about *RX Gain* and overload condition.

Using the Audio Tone

Before You Begin

Create your own cable adapter to connect the *AUX* port to your headphones or other listening device. The cable adapter requires two items:

- An RJ-12 cable with an RJ-12 connector
 - A cable with a 3.5 mm, female, stereo phono jack (mono jack is acceptable)
1. Attach the wire from pin 6 of the RJ-12 cable to the return or shield wire of the 3.5 mm jack.
 2. Attach the wire from pin 5 of the RJ-12 cable to both the left and right channel wires of the 3.5 mm stereo phono jack.

Note: For a mono jack, connect the wire from pin 5 to the + wire of the mono jack.

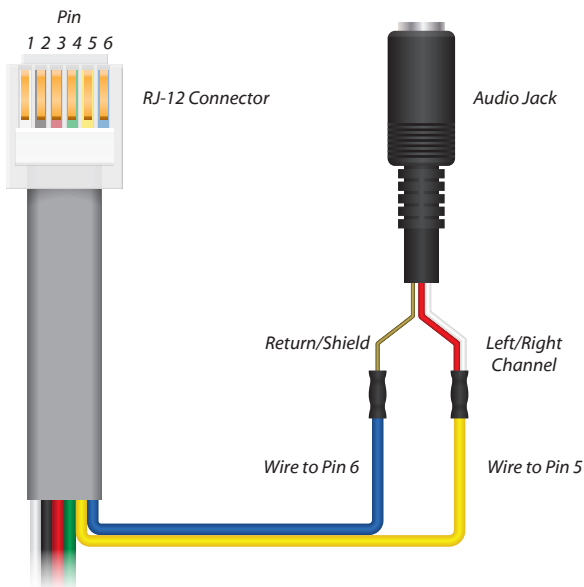

Pinouts from RJ-12 to 3.5 mm Stereo Phono Jack

Note: Wire colors may vary on RJ-12 cables.

3. Attach the RJ-12 connector to the *AUX* port of the airFiber AF-24.
4. Connect a pair of headphones (or other listening device) to the female audio jack.

Establishing a Preliminary Link

Adjust the positions of the *Master* and the *Slave* to establish a preliminary link. This requires the *Master* and *Slave* to be within a few degrees of the line of sight between the airFiber radios.

Note: The *Master* must be aimed first at the *Slave* because the *Slave* does not transmit any RF signal until it detects transmissions from the *Master*.

1. For the *Master* and *Slave*, ensure the eight *Lock Bolts* on the *Alignment Bracket* are sufficiently loose by spinning each washer by hand.

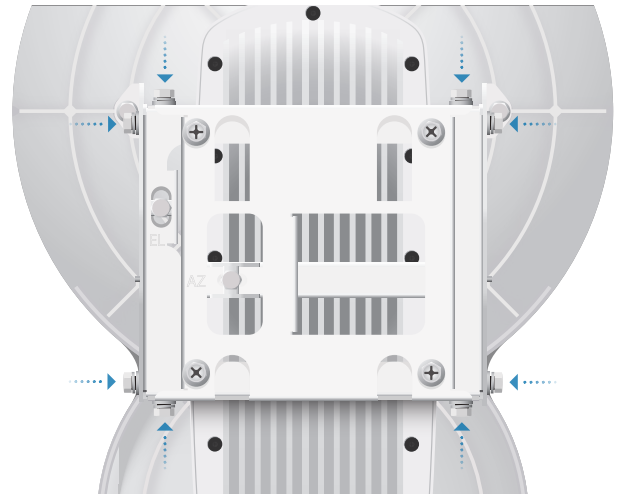

WARNING: All *Lock Bolts* MUST be loose to avoid damage to the airFiber housing.

2. For the *Master* and *Slave*, ensure the *Azimuth (AZ)* and *Elevation (EL)* *Adjustment Bolts* are in the middle of their adjustment ranges.



3. **Master** Aim the *Master* at the *Slave*. If necessary, adjust the *Master's* position on the pole:
 - a. Loosen the *Hex Nuts*.
 - b. Adjust the *Pole Mount Bracket* and *Pole Clamps*.
 - c. Tighten the *Hex Nuts*.

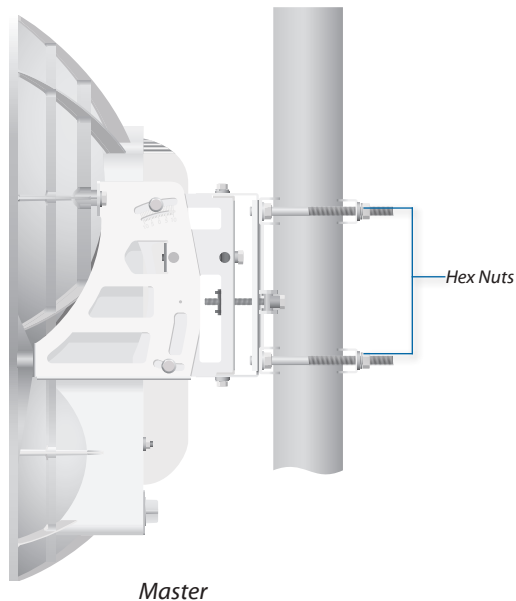

4. **Slave** Listen to the audio tone of the *Slave* – the higher the pitch, the stronger the signal strength. Aim the *Slave* at the *Master* to achieve the strongest signal strength. If necessary, adjust the *Slave's* position on the pole.
5. **Master** Adjust the azimuth and elevation of the *Master* until you hear the highest pitch for the *Master*.
 - a. Sweep the *Azimuth (AZ) Adjustment Bolt* of the *Master* through its adjustment range.

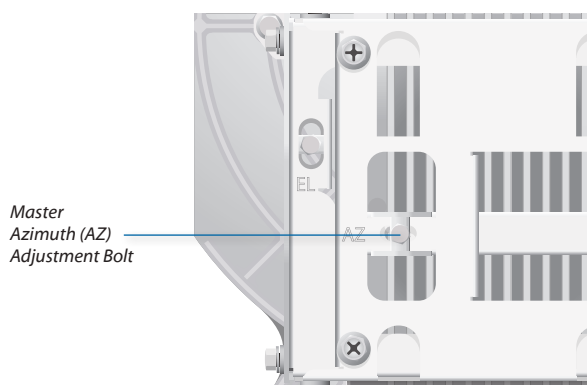

- b. Sweep the *Elevation (EL) Adjustment Bolt* of the *Master* through its adjustment range.

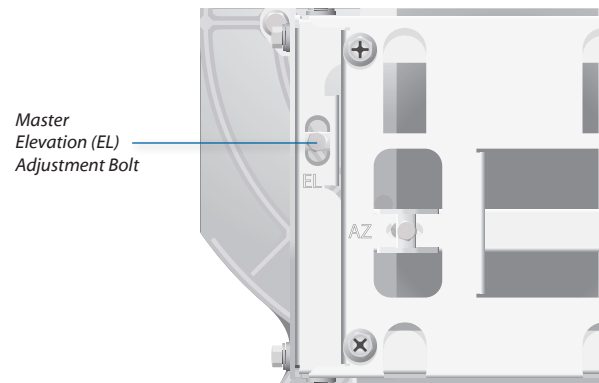

Fine-Tuning the Link

The *Azimuth (AZ)* and *Elevation (EL) Adjustment Bolts* of the *Alignment Bracket* adjust the azimuth and elevation within a range of $\pm 10^\circ$. For accurate alignment, make adjustments on one end of the link while the other installer listens to the audio tone at the other end of the link. Do NOT make simultaneous adjustments on the *Master* and *Slave*.

1. **Slave** Adjust the azimuth and elevation of the *Slave* until the other installer hears the highest pitch for the *Master*.
2. **Master** Adjust the azimuth and elevation of the *Master* until the other installer hears the highest pitch for the *Slave*.
3. Repeat steps 1 and 2 until you achieve a symmetric link, with the received signal levels within 1 dB of each other. This ensures the best possible data rate between the airFiber radios.

 **Note:** If you have difficulty discerning whether the link is symmetric, you can use one of the following methods to determine more precise received signal level readings.

- LED Display (See [“Using the LED Display” on page 13.](#))
- airFiber Configuration Interface (See [“Using the airFiber Configuration Interface” on page 15.](#))

4. Lock the alignment on both airFiber radios by tightening all eight *Lock Bolts* on the *Alignment Bracket*.

Listen to the audio tone for each airFiber AF-24 to ensure that the value remains constant while tightening the *Lock Bolts*. If the audio tones change during the locking process, loosen the *Lock Bolts*, finalize the alignment of each airFiber AF-24 again, and retighten the *Lock Bolts*.

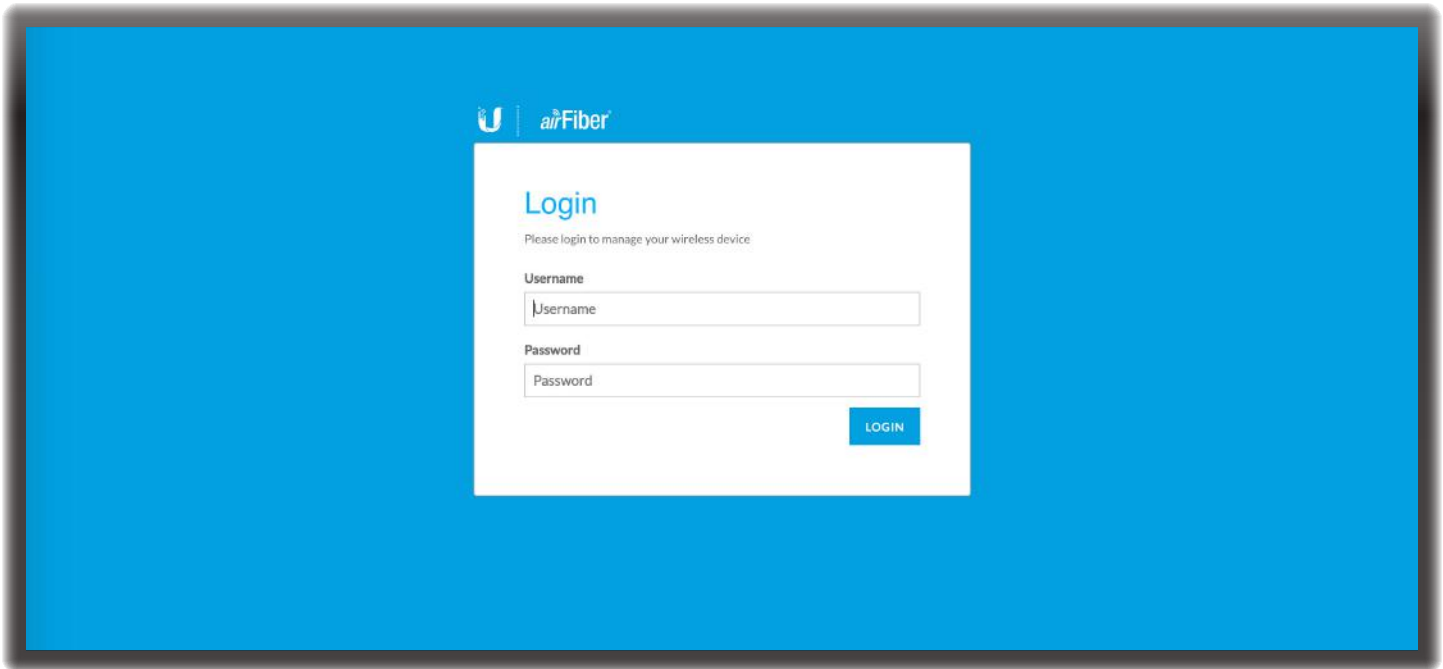

Chapter 3: Navigation

The airFiber Configuration Interface is an advanced operating system capable of powerful wireless and routing features, built upon a simple and intuitive user interface foundation.

The airFiber AF-24 uses the airFiber Configuration Interface for easy configuration and management via a web browser.

There are two ways to access the airFiber Configuration Interface:

- **Config Port** Enabled by default. Use a direct connection to the *Config* port for out-of-band management.
- **In-Band Management** Enabled by default. In-band management is available through the local *Data* port or the *Data* port at the other end of the link. You can disable it on the *Network* tab. (See [“Management Network Settings” on page 33](#) for more details.)

Accessing the airFiber Configuration Interface

Connect to the airFiber Configuration Interface.

1. Make sure that your host machine is connected to the LAN that is connected to the *Config* port on the airFiber AF-24.
2. Configure the Ethernet adapter on your host system with a static IP address on the 192.168.1.x subnet (for example, 192.168.1.100).
3. Launch your web browser. Type **http://192.168.1.20** in the address field and press **enter** (PC) or **return** (Mac).

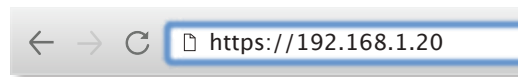

4. Upon initial login, the *Terms of Use* appear on the login screen. Enter **ubnt** in the *Username* and *Password* fields, and select the appropriate choices from the *Country* and *Language* drop-down lists. Check the box next to *I agree to these terms of use*, and click **Login**.

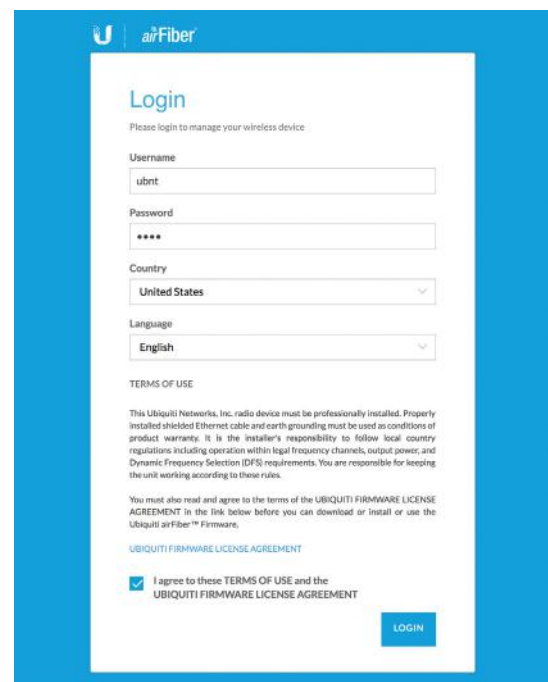

Note: U.S. product versions are locked to the U.S. Country Code to ensure compliance with FCC regulations.

5. The airFiber Configuration Interface will appear, allowing you to customize your settings as needed.

Navigating the Interface

The airFiber Configuration Interface contains two main pages. Each web-based management page is used to configure a specific aspect of the AF-24/AF-24HD radio, and is accessed by clicking its icon in the navigation bar on the left side of the interface:

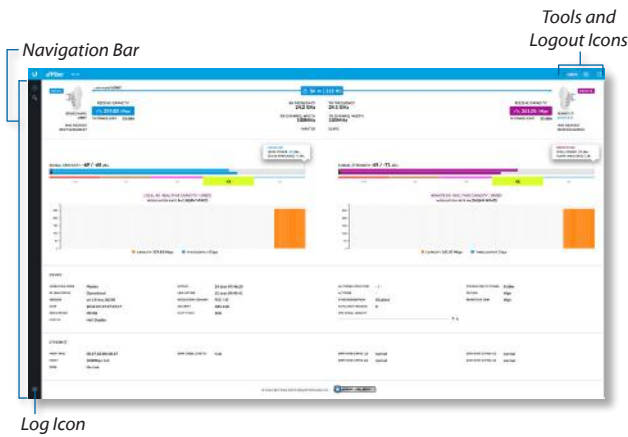

At the lower left and upper right of the window are icons used to access additional tools and information:

Icon	Web-Based Management Page
	Opens the Ubiquiti Network Management System (UNMS™) website (unms.com) in a new browser tab.
	Displays the <i>Tools</i> menu. For details, refer to “Tools” on page 45.
	Click this icon to immediately log out of the airFiber Configuration Interface.

Keyboard Shortcuts

Keyboard shortcuts allow you to access the Configuration Interface pages, tabs, and tools by pressing a single key or two keys.

Press ? at any time to display the keyboard shortcut menu.

Icon	Web-Based Management Page
	Displays the <i>Dashboard</i> , with device and link status, statistics, and network monitoring and RF performance data. For details, refer to “Dashboard” on page 25.
	Displays the <i>Settings</i> page with these tabs: <ul style="list-style-type: none"> • Wireless Configures the wireless settings, including wireless mode, link name, channel bandwidth and frequency, output power, gain, and wireless security. For details, refer to “Wireless Tab” on page 29. • Network Configures the network mode; data port settings; management port settings; and Ethernet carrier drop settings. For details, refer to “Network Tab” on page 33. • Services Configures system management services: Bluetooth management, Ping Watchdog, Simple Network Management Protocol (SNMP), servers (web, SSH, Telnet), Network Time Protocol (NTP) client, Dynamic Domain Name System (DDNS) client, system log, and device discovery. For details, refer to “Services Tab” on page 37. • System Controls system maintenance, such as firmware updates, device and date settings, system account settings, location settings, device maintenance, and configuration backup. You can also change the language of the web management interface. For details, refer to “System Tab” on page 41.
	Displays the system log. For details, refer to “Log” on page 49.

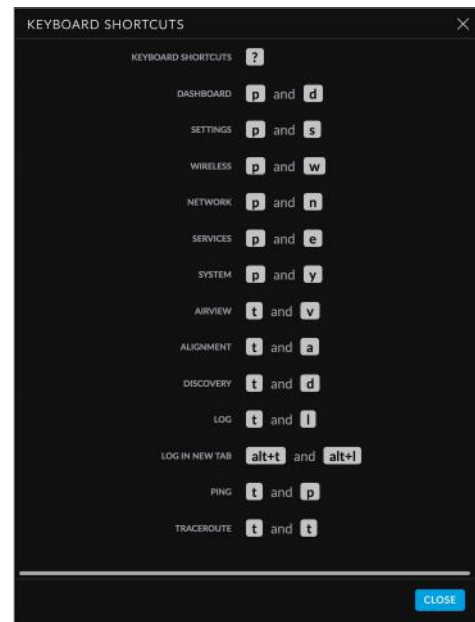

- ? Displays the list of keyboard shortcuts.
- pd Displays the *Dashboard*.
- ps Displays the *Settings* page.
- pw Displays the *Wireless* tab of the *Settings* page.
- pn Displays the *Network* tab of the *Settings* page.
- pe Displays the *Service* tab of the *Settings* page.
- py Displays the *System* tab of the *Settings* page.
- tv Displays the *airView* tool.
- ta Displays the *Antenna Alignment* tool.
- td Displays the *Device Discovery* tool.
- alt+t alt+l Opens the login screen in a new tab.
- tp Displays the *Ping* tool.
- tt Displays the *Traceroute* tool.
- Close Click to close the shortcut menu.

Notifications

Pending Changes

When you make changes to any settings on any page, the following buttons appear at the bottom of the page:



Use the buttons to perform operations on all unsaved changes. You have three options:

Test Changes Click **Test Changes** to try changes without saving them. You have two options:

- **Apply** Click **Apply** to save changes.
- **Discard** Click *Discard* to cancel changes.



Note: If you do not click **Apply** within 180 seconds (the countdown is displayed), the device times out and resumes its earlier configuration.

Revert Changes Click **Revert Changes** to cancel all pending changes on all pages.

Save Changes Click **Save Changes** to immediately apply and save changes.

Product Verification

The airFiber Configuration Interface will verify whether a product is genuine or counterfeit.

For a genuine airFiber AF-24, the airFiber Configuration Interface will display a Genuine Product logo in the lower left corner of the screen.



For any product that is not an official Ubiquiti product, the airFiber Configuration Interface will display a counterfeit warning. Please contact Ubiquiti at support@ubnt.com regarding this product.



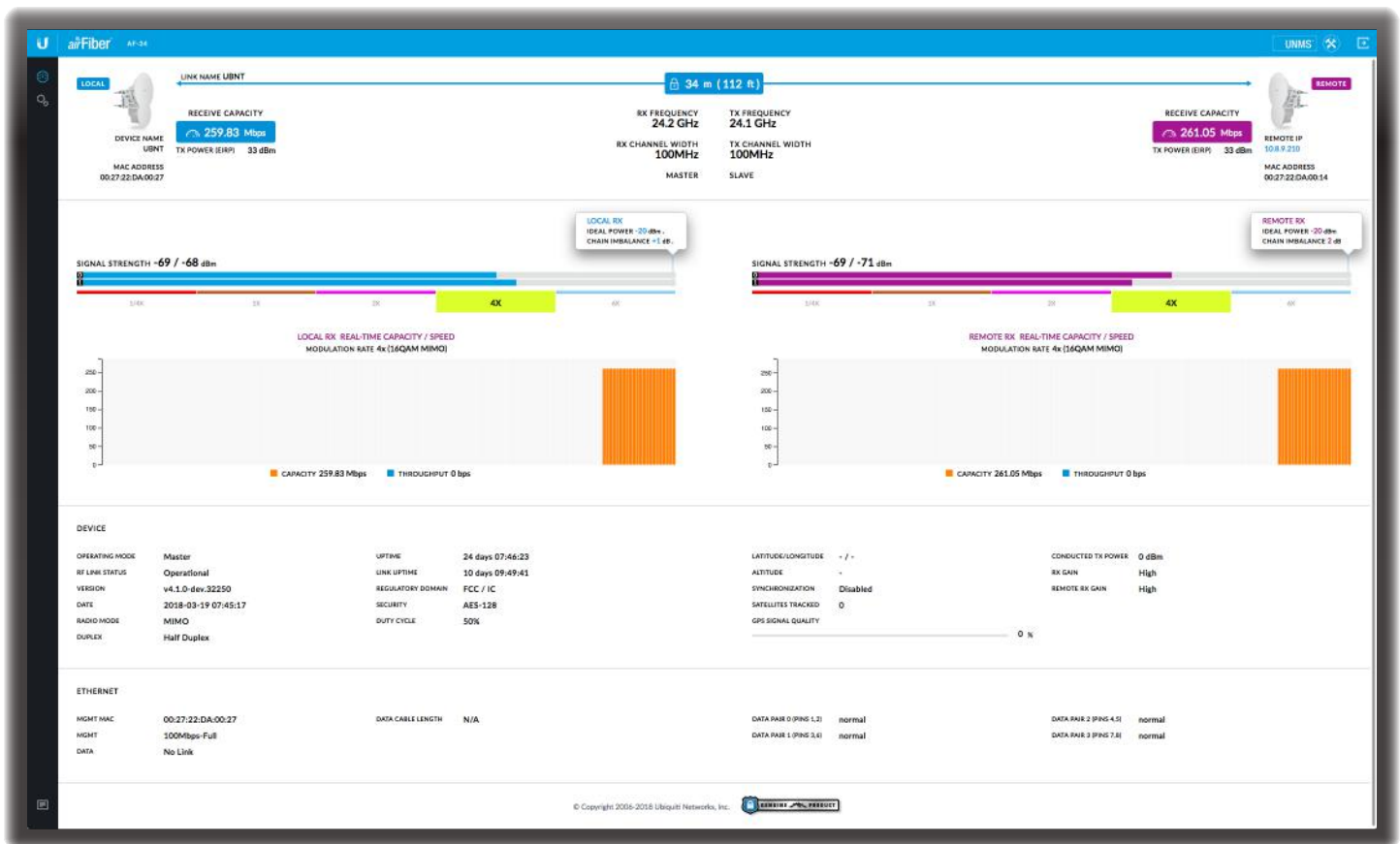

Chapter 4: Dashboard

The *Dashboard* displays a visual summary of the link status, basic configuration settings, network settings and information, and traffic statistics. Where applicable, information is displayed for both the local device (on the left) and the remote device (on the right).

Link Status

The top section of the *Dashboard* displays the status of the link and the local and remote devices as follows:

RF Link

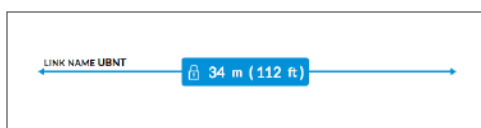

Link Name Displays the name of your link.

(Distance) Displays the distance between the local and remote radios. The lock icon appears if the link is connected (no icon is shown if there is no connection).

Local Device

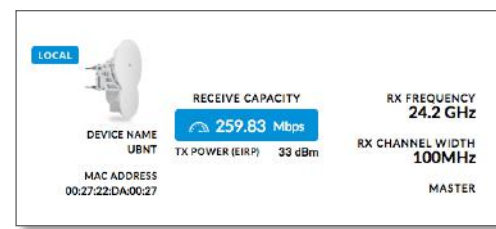

Device Name Displays the local device's customizable name or identifier. The *Device Name* (or host name) is displayed in registration screens and discovery tools.

MAC Address Displays the local device's MAC address.

Receive Capacity Displays the local device's receive capacity in Mbps.

TX Power EIRP Displays the local device's current average transmit output power (in dBm).

RX Frequency Displays the local device's current receive frequency.

RX Channel Width Displays the local device's current channel bandwidth in MHz.

(Wireless Mode) Displays the mode of the local airFiber radio: *Master* or *Slave*.

Remote Device

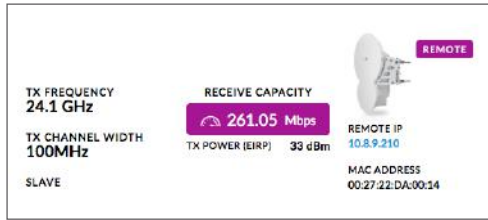

- Remote IP** Displays the remote device’s IP address.
- MAC Address** Displays the remote device’s MAC address.
- Receive Capacity** Displays the remote device’s receive capacity in Mbps.
- TX Power EIRP** Displays the remote device’s current average transmit output power (in dBm).
- TX Frequency** Displays the remote device’s current transmit frequency.
- TX Channel Width** Displays the remote device’s current channel bandwidth in MHz.
- (Wireless Mode)** Displays the mode of the remote airFiber radio: *Master* or *Slave*.

Statistics

The next section of the *Dashboard* displays various information in graphical form:

Signal Strength xx/yy dBm Displays the actual (xx) and ideal (yy) power levels in dBm of the received signal for each chain of the local or remote device.

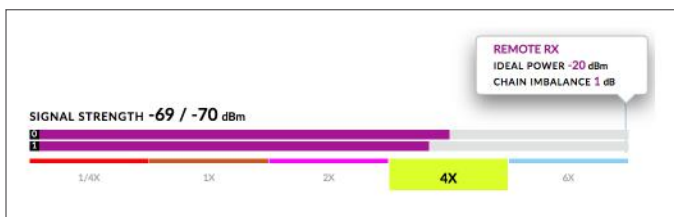
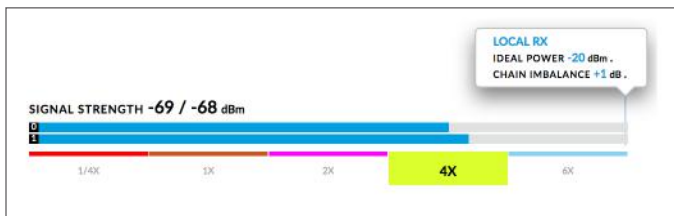

The actual number indicates the current RX signal strength. The ideal number is the RX signal strength of a perfectly aligned link. These two numbers indicate exactly how many dB out of alignment the system is.

The colored bar indicates the relative signal strength. If the bar does not span the full width of the graph, your link is not optimally aimed.

Below the signal strength graph, the current modulation rate is displayed for the local or remote device:

- 6x (64QAM MIMO)
- 4x (16QAM MIMO)
- 2x (QPSK MIMO)
- 1x (QPSK SISO)
- 1/4 x (QPSK SISO)

Above the graph, the following are displayed:

- **Ideal Power** Displays the expected receive power in dBm.
 - **Chain Imbalance** Displays the chain imbalance in dB.
- Local/Remote RX Real-Time Capacity / Speed** Displays the capacity and throughput rates for the local and remote device. Capacity is indicated by the filled area of the graph; throughput is indicated by the solid line.

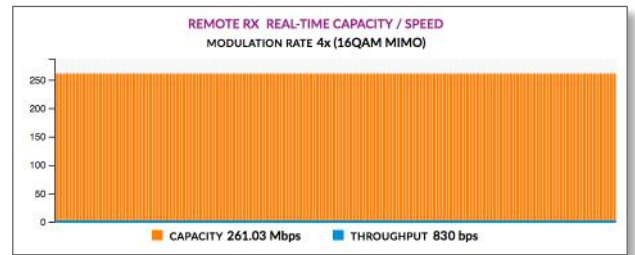
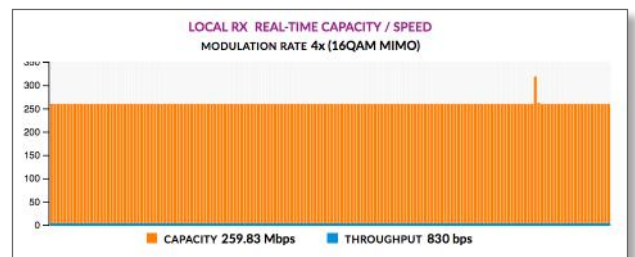

The capacity is the expected maximum rate at which data can be transmitted over the channel (accounting for protocol overhead and interference).

The capacity graph displays the potential data traffic on the *DATA* port in both graphical and numerical form. The chart scale and capacity dimension (bps, kbps, Mbps) change dynamically depending on the mean capacity value. The statistics are updated automatically.

The throughput graph displays the current data traffic on the *DATA* port in both graphical and numerical form. The chart scale and throughput dimension (bps, kbps, Mbps) change dynamically depending on the mean throughput value. The statistics are updated automatically.

Device Status

The next section of the *Dashboard* displays additional status information for the local device.

DEVICE					
OPERATING MODE	Master	UPTIME	24 days 07:48:53	LATITUDE/LONGITUDE	- / -
RF LINK STATUS	Operational	LINK UPTIME	10 days 09:52:11	ALTITUDE	-
VERSION	v4.1.0-dev.32250	REGULATORY DOMAIN	FCC / IC	SYNCHRONIZATION	Disabled
DATE	2018-03-19 07:47:47	SECURITY	AES-128	SATELLITES TRACKED	0
RADIO MODE	MIMO	DUTY CYCLE	50%	GPS SIGNAL QUALITY	0 %
DUPLEX	Half Duplex			CONDUCTED TX POWER	0 dBm
				RX GAIN	High
				REMOTE RX GAIN	High

Operating Mode Displays the mode of the local airFiber radio: *Master, Slave, or Reset*.

RF Link Status Displays the status of the airFiber AF-24: *RF Off, Syncing, Beaconing, Registering, Enabling, Listening, or Operational*.

Version Displays the version of the firmware running in the local device.

Date Displays the current system date and time (the format is browser and location-dependent). The system date and time is retrieved from the internet using NTP (Network Time Protocol). The NTP Client is disabled by default on the *Services* page. The device doesn't have an internal clock, and the date and time may be inaccurate if the NTP Client is disabled or the device isn't connected to the internet.

Radio Mode Always displays MIMO (SISO mode is not supported).

Duplex Displays *Full Duplex* or *Half Duplex*. *Full duplex* mode allows communication in both directions simultaneously. *Half duplex* mode allows communication in one direction at a time, alternating between transmission and reception.

Uptime This is the total time the device has been running since the latest reboot (when the device was powered up) or software upgrade. The time is displayed in days, hours, minutes, and seconds.

Link Uptime Displays the total time the airFiber link has been continuously operational. The time is displayed in days, hours, minutes, and seconds.

Regulatory Domain Displays the regulatory domain (*FCC/ICC, ETSI, or Other*), as determined by country selection.

Security AES-128 is enabled at all times.

Duty Cycle Displays the duty cycle.

Latitude/Longitude Based on GPS tracking, reports the local device's current latitude and longitude. Clicking the link opens the reported latitude and longitude in a browser using Google Maps™ (<http://maps.google.com>).

Altitude Based on GPS tracking, reports the local device's current altitude relative to sea level.

Synchronization airFiber uses GPS to synchronize the timing of its transmissions. By default, this option is *Disabled*.

Satellites Tracked Displays the number of satellites tracked by the GPS receiver.

GPS Signal Quality Displays Global Positioning System (GPS) signal quality as a percentage value on a scale of 0-100%.

Conducted TX Power Displays the conducted transmit power out of the radio before any antenna gain.

RX Gain Displays the gain for the RX antenna of the local AF-24 device: *High* or *Low*.

Remote RX Gain Displays the gain for the RX antenna of the remote AF-24 device: *High* or *Low*.

Ethernet Connection Status

ETHERNET					
MGMT MAC	00:27:22:DA:00:27	DATA CABLE LENGTH	N/A	DATA PAIR 0 (PINS 1,2)	normal
MGMT	100Mbps - Full			DATA PAIR 1 (PINS 3,6)	normal
DATA	No Link			DATA PAIR 2 (PINS 4,5)	normal
				DATA PAIR 3 (PINS 7,8)	normal

Mgmt MAC Displays the MAC address of the *Config* port.

Mgmt Displays the speed and duplex of the *Config* port.

Data Displays the speed and duplex of the *Data* port.

Data Cable Length Displays the length of the Ethernet data cable attached to the local radio. This is displayed only for cables longer than 20 m.

Data Pair 0 (Pins 1, 2) If the cable is functioning properly, this field displays the SNR of the twisted pair. If the cable has a fault, the field displays the fault (*Open* or *Short*) and the distance at which the fault has occurred. If the remote port is administratively shut down, *Normal* is displayed.

Data Pair 1 (Pins 3, 6) If the cable is functioning properly, this field displays the SNR of the twisted pair. If the cable has a fault, the field displays the fault (*Open* or *Short*) and the distance at which the fault has occurred. If the remote port is administratively shut down, *Normal* is displayed.

Data Pair 2 (Pins 4, 5) If the cable is functioning properly, this field displays the SNR of the twisted pair. If the cable has a fault, the field displays the fault (*Open* or *Short*) and the distance at which the fault has occurred. If the remote port is administratively shut down, *Normal* is displayed.

Data Pair 3 (Pins 7, 8) If the cable is functioning properly, this field displays the SNR of the twisted pair. If the cable has a fault, the field displays the fault (*Open* or *Short*) and the distance at which the fault has occurred. If the remote port is administratively shut down, *Normal* is displayed.

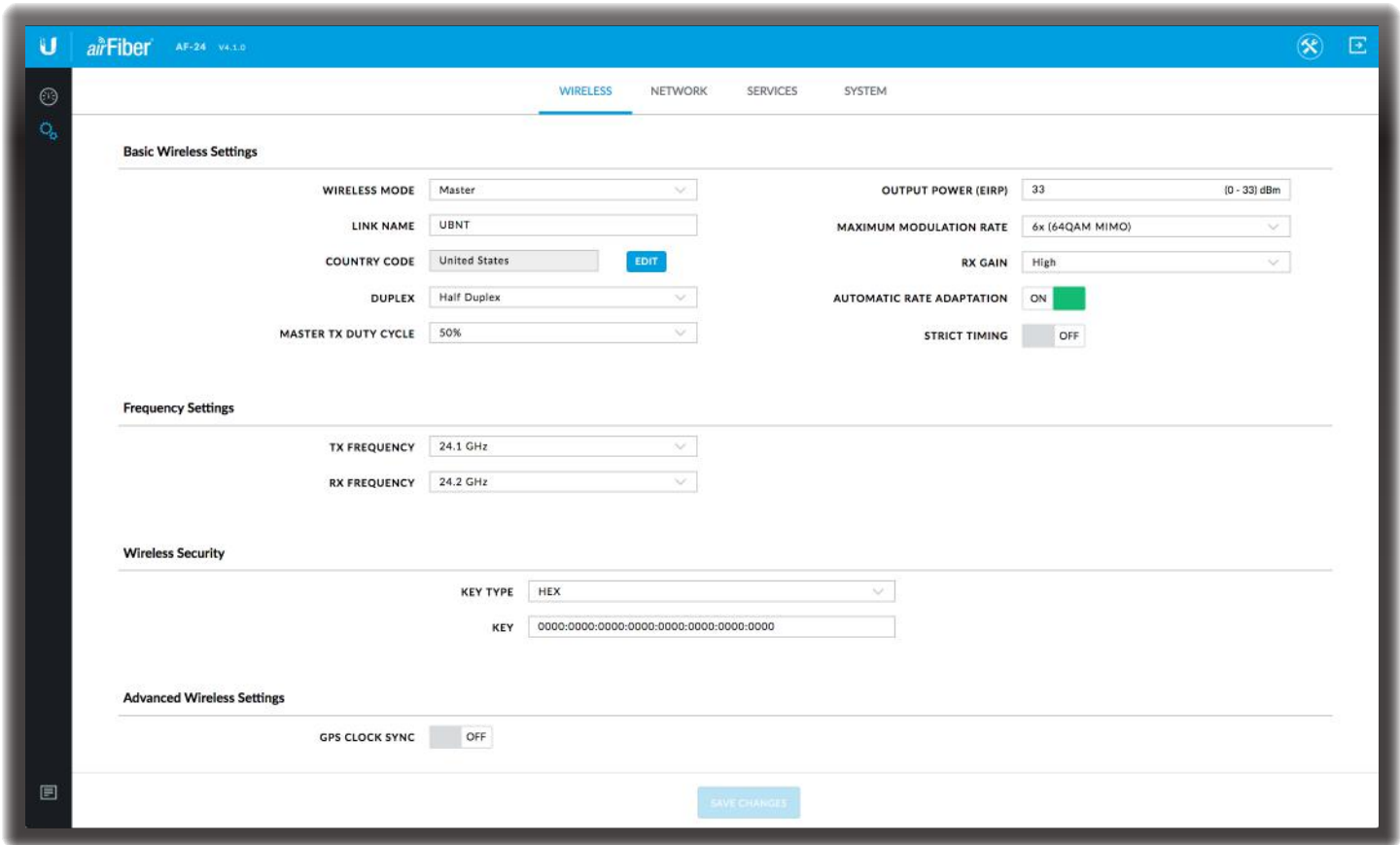

Chapter 5: Wireless Tab

The *Wireless* tab contains everything needed to set up the wireless part of the link. This includes wireless mode, link name, frequencies, output power, speed, gain, and wireless security.

Write down the settings you configure on the *Wireless* tab. You will need to enter the same settings on the airFiber AF-24 at the other end of your PtP link. The exceptions are as follows:

- **Wireless Mode** Configure one airFiber AF-24 as the *Master* and the other as the *Slave*.
- **TX and RX Frequencies** The *TX Frequency* on the Master should be used as the *RX Frequency* on the Slave, and vice versa.

For *Half Duplex* mode (default), the *TX* and *RX Frequencies* can be the same or different frequencies, in response to local interference.

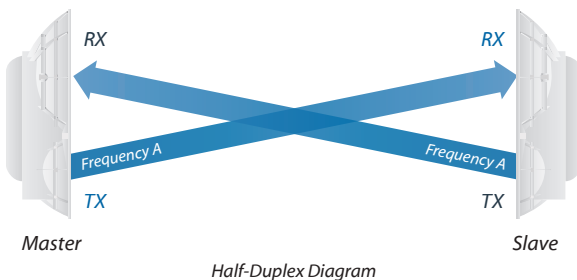

For *Full Duplex* mode, the *TX* and *RX Frequencies* should be different.

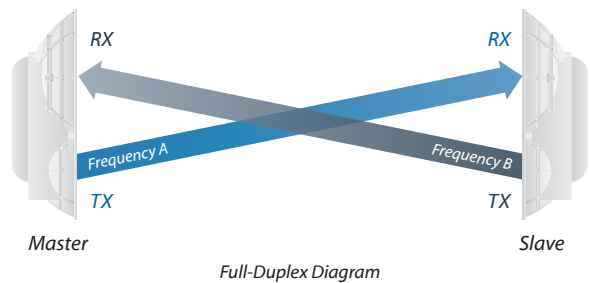

Basic Wireless Settings

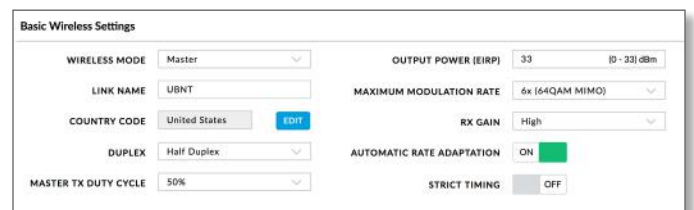

In this section, configure the basic wireless settings, such as wireless mode, link name, country code, duplex, duty cycle, output power, modulation rate, gain, and rate adaptation.

Wireless Mode By default, the Wireless Mode is *Slave*. You must configure one airFiber AF-24 to **Master** because each PtP link must have one *Master*.

Link Name Enter a name for your PtP link.

Country Code Each country has its own power level and frequency regulations. *To ensure the airFiber AF-24 operates under the necessary regulatory compliance rules, you must select the country where your device will be used.* The frequency settings and output power limits will be tuned according to the regulations of the selected country.

- **Edit** To select a new country, click **Edit**.



Note: U.S. product versions are locked to the U.S. Country Code to ensure compliance with FCC regulations.

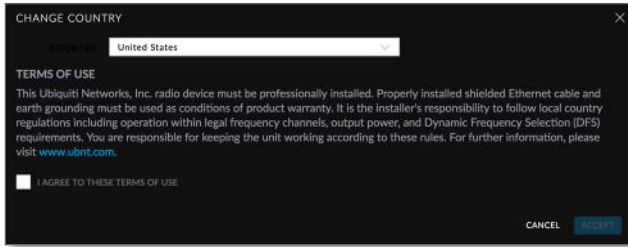

- **Change Country** Select the new country.
- **I agree to these terms of use** Check this box; you must agree to the *Terms of Use* to use the product.
- **Accept** Saves your change.
- **Cancel** Discards your change.

Duplex Select **Half Duplex** or **Full Duplex**. Half-duplex operation provides more frequency planning options at the cost of higher latency and throughput. (Half-duplex mode allows communication in one direction at a time, alternating between transmission and reception.) Full-duplex operation provides the highest throughput and lowest latency; however, you have fewer frequency management options. (Full-duplex mode allows communication in both directions simultaneously.)



Note: For *Half Duplex* mode (default), the *TX* and *RX Frequencies* on the same airFiber AF-24 can be the same or different to suit local interference. For *Full Duplex* mode, the *TX* and *RX Frequencies* on the same airFiber AF-24 should be different.

Master TX Duty Cycle Used to select the duty cycle of the Master transmit link: **25%**, **33%**, **50%**, **67%**, or **75%**.

Output Power (EIRP) Defines the maximum average transmit output power (in dBm) of the airFiber AF-24. To specify the output power, manually enter the output power value. The transmit power level maximum is limited according to country regulations.

Maximum Modulation Rate / Modulation Rate Higher modulations allow greater throughput but generally require stronger RF signals and a higher Signal-to-Noise Ratio (SNR). By default, *Automatic Rate Adaptation* is enabled, and *Maximum Modulation Rate* is displayed. This allows the airFiber AF-24 to automatically adjust the modulation rate to changing RF signal conditions. Under certain conditions, you may prefer to lock the *Maximum Modulation Rate* to a lower setting to improve link performance.

When *Automatic Rate Adaptation* is disabled, *Modulation Rate* is displayed. Lock the *Modulation Rate* to the setting of your choice.

Select one of the available modulation rates:

- **8x (256QAM MIMO)** (AF-24HD only)
- **6x (64QAM MIMO)**
- **4x (16QAM MIMO)**
- **2x (QPSK MIMO)**
- **1x (QPSK SISO)**
- **1/4x (QPSK SISO)**

RX Gain Select the appropriate gain for your RX antenna: **High** (default) or **Low**. If the link is very short or being tested, select **Low**, so your signal does not get distorted.



Note: Minimum link distance is approximately 100 m (328 ft).

For links between 100 m (328 ft) and 800 m (2,625 ft):

- Target -40 dBm.
- Decrease *RX Gain* to overcome overload condition (ΔL).
- For short ranges or strong signal conditions, adjust the power to be 3-5 dB below overload condition (ΔL).
- Decrease *RX Gain* first.
- Never mitigate overload condition (ΔL) by misaligning antennas.

Link Distance	RX Gain Setting	Approximate TX Power Setting
d > 1 km (d > 3,281 ft)	High	> 25 dBm
0.5 km < d < 1 km (1,640 ft < d < 3,281 ft)	Low	19-25 dBm
0.25 km < d < 0.5 km (820 ft < d < 1,640 ft)	Low	12-18 dBm
0.1 km < d < 0.25 km (328 ft < d < 820 ft)	Low	3-11 dBm

Automatic Rate Adaptation Set this to **On** to enable automatic adaptation of the *Maximum Modulation Rate*. Set this to **Off** to manually specify the *Modulation Rate*.

Strict Timing Enabling this shortens the TX window slightly (reduces capacity) to compensate for half duplex co-located links where the distance covered by each differs greatly. This can be used to eliminate potential co-location interference. This should only need to be enabled when co-location interference is suspected.

Frequency Settings

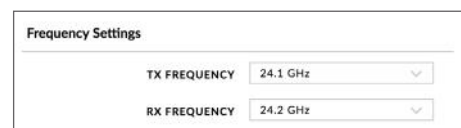

This section allows you to configure the transmit and receive frequencies for the local AF-24 device.

TX Frequency Select a transmit frequency.

 **Note:** The *TX Frequency* on the Master should be used as the *RX Frequency* on the Slave, and vice versa.

RX Frequency Select a receive frequency.

Wireless Security

airFiber uses 128-bit, AES (Advanced Encryption Standard) encryption at all times.



Key Type Specifies the character format.

- **HEX** By default, this option uses hexadecimal characters. 0-9, A-F, or a-f are valid characters.
- **ASCII** ASCII uses the standard English alphabet and numeric characters (0-9, A-Z, or a-z).

Key Select the format of the MAC address.

- **HEX** Enter 16 bytes (eight, 16-bit HEX values). You can omit zeroes and use colons, similar to the IPv6 format. The default is:
0000:0000:0000:0000:0000:0000:0000:0000.

 **Note:** The airFiber Configuration Interface supports IPv6 formats excluding dotted quad and “::” (double-colon) notation.

- **ASCII** Enter a combination of alphanumeric characters. Using 128-bit, SHA1 (Secure Hash Algorithm 1), airFiber AF-24 hashes the ASCII key to create a 128-bit key for AES.

Advanced Wireless Settings

This section allows you to configure advanced wireless settings such as GPS clock synchronization.

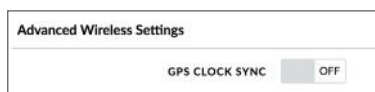

GPS Clock Sync The airFiber AF-24 uses GPS to synchronize the timing of its transmissions. By default, this option is disabled.

Chapter 6: Network Tab

The *Network* tab allows you to configure settings for the management network. There are two ways to access the airFiber Configuration Interface:

- **Config Port** Enabled by default. Use a direct connection to the *Config* port for out-of-band management.
- **In-Band Management** Enabled by default. In-band management is available through the local *Data* port or the *Data* port at the other end of the link.

The *Config* port and in-band management share the default IP address of *192.168.1.20*.

Management Network Settings

In-Band Management Enabled by default. In-band management is available through the local *Data* port or the *Data* port at the other end of the link.

Note: If *In-Band Management* is enabled, ensure that each airFiber radio of a link has a unique *IP Address*. If the airFiber radios use the same *IP Address*, then you may lose access via the *Data* ports.

Management IP Address The AF-24 can use a static IP address or obtain an IP address from its DHCP server.

- **DHCP** Keep the default, *DHCP*, to use DHCP reservation on your router to assign a unique *IP Address*. The local DHCP server function of the router assigns a dynamic IP address, gateway IP address, and DNS address to the airFiber AF-24.

Note: If you do not know the IP address, the only way to manage the airFiber AF-24 is to reset it to its factory default settings. (Press and hold the **Reset** button for more than five seconds.) Its default *Management IP Address* is reset to *192.168.1.20*.

- **DHCP Fallback IP** Specify the IP address the AF-24 should use if a DHCP server is not found.
- **DHCP Fallback Netmask** Specify the netmask the AF-24 should use if a DHCP server is not found.
- **Static** Assign static IP settings to the airFiber AF-24.

Note: IP settings should be consistent with the address space of the AF-24's network segment.

- **IP Address** Specify the IP address of the AF-24. This IP will be used for device management purposes.

- **Netmask** When the netmask is expanded into its binary form, it provides a mapping to define which portions of the IP address range are used for the network devices and which portions are used for host devices. The netmask defines the address space of the airFiber AF-24's network segment. The 255.255.255.0 (or "/24") netmask is commonly used on many Class C IP networks.
- **Gateway IP** Typically, this is the IP address of the host router, which provides the point of connection to the internet. This can be a DSL modem, cable modem, or WISP gateway router. The airFiber AF-24 directs data packets to the gateway if the destination host is not within the local network.
- **Primary DNS IP** Specify the IP address of the primary DNS (Domain Name System) server.
- **Secondary DNS IP** Specify the IP address of the secondary DNS server. This entry is optional and used only if the primary DNS server is not responding.

Management VLAN If enabled, automatically creates a management Virtual Local Area Network (VLAN).

- **VLAN ID** (Available if *Management VLAN* is enabled.) Enter a unique VLAN ID from 2 to 4094.

Auto IP Aliasing If enabled, automatically generates an IP address for the corresponding WLAN/LAN interface. The generated IP address is a unique Class B IP address from the 169.254.X.Y range (netmask 255.255.0.0), which is intended for use within the same network segment only. The Auto IP always starts with 169.254.X.Y, with X and Y as the last two octets from the MAC address of the airFiber AF-24. For example, if the MAC address is 00:15:6D:A3:04:FB, then the generated unique Auto IP will be 169.254.4.251. (The hexadecimal value, *FB*, converts to the decimal value, *251*.)

The Auto IP Aliasing setting can be useful because you can still access and manage devices even if you lose, misconfigure, or forget their IP addresses. Because an Auto IP address is based on the last two octets of the MAC address, you can determine the IP address of a device if you know its MAC address.

airView Port The port number associated with the airView spectrum analyzer tool. The default value is 18888. For detailed information on the airView tool, refer to **"airView" on page 47**.

Mgmt Speed This is the speed of the *Management* port. By default, the option is **Auto**. The airFiber X radio automatically negotiates transmission parameters, such as speed and duplex, with its counterpart. In this process, the networked devices first share their capabilities and then choose the fastest transmission mode they both support.

To manually specify the maximum transmission link speed and duplex mode, select one of the following options: **100 Mbps-Full**, **100 Mbps-Half**, **10 Mbps-Full**, or **10 Mbps-Half**. If you are running extra long Ethernet cables, a link speed of 10 Mbps could help to achieve better stability.

Full-duplex mode allows communication in both directions simultaneously. Half-duplex mode allows communication in one direction at a time, alternating between transmission and reception.

Data Port Ethernet Settings



Data Speed This is the speed of the *Data* port. The default is **Auto**, which allows the radio to operate at a speed of 1 Gbps. The AF-24 radio automatically negotiates transmission parameters, such as speed and duplex, with its counterpart. In this process, the networked devices first share their capabilities and then choose the fastest transmission mode they both support.

To manually specify the maximum transmission link speed and duplex mode, select one of the following options: **100 Mbps-Full**, **100 Mbps-Half**, **10 Mbps-Full**, or **10 Mbps-Half**.

Full-duplex mode allows communication in both directions simultaneously. Half-duplex mode allows communication in one direction at a time, alternating between transmission and reception.

Flow Control If enabled, the AF-24 radio generates and responds to Ethernet layer PAUSE frames. The AF-24 radio regulates inbound traffic from the customer's network to avoid buffer overflows within the AF-24 radio. Flow control has the effect of controlling the inter-packet spacing of packets headed into the airFiber Data interface.

Multicast Filter If enabled, the filter blocks multicast traffic from overloading the CPU when in-band management is enabled. This allows the AF-24 radio to be managed in-band when the customer's network is carrying large volumes of multicast traffic, such as IPTV. The filter does not block multicast traffic going over the radio; it simply blocks it from reaching the AF-24 radio's management interface CPU.

Ethernet Carrier Drop Settings

The *Ethernet Carrier Drop* settings are used to control failover switching between the primary and backup link in response to capacity loss due to rain.



Carrier Drop Operation This setting is used to control the *Ethernet Carrier Drop* feature. Settings are: *Disabled*, *Enabled*, and *Use Pulse*. The default is *Disabled*.

Use Pulse and *Enabled* are the two different methods used to signal to the failover mechanism that it should switch to the backup link:

- **Use Pulse** The LAN link is toggled off.
- **Enabled** The LAN link will be turned off and left off.

Pulse Duration (Available if *Carrier Drop Operation* is set to *Use Pulse*.) This is the length of time that the LAN link remains down to trigger failover. The default is 5 seconds.

Block Data After Pulse (Available if *Carrier Drop Operation* is set to *Use Pulse*.) Enable this option to stop data from passing through the link when it is experiencing loss of capacity. The default is *Off*.

Enable Ethernet If No Session Enable this option to allow management data (such as GUI, SNMP, and ping packets) to pass, even if the *Block Data After Pulse* option is enabled. The default is *Off*.

Wait for First Session Enable this option to cause the system to wait until the Ethernet link has been successfully established following a power cycle, to keep the link from being dropped due to the throughput being below threshold. The default is *Off*.

First Session Validation Timer Use this setting to specify how long to wait before triggering a link failure due to insufficient threshold capacity following a power cycle. The default is 0 seconds.

TX Capacity Low Threshold This is the minimum allowable TX capacity; if the TX capacity goes below this threshold, the Ethernet link will be dropped. The default is 0 Mbps.

TX Capacity High Threshold This is the TX capacity required before a dropped link can be declared to be operational again. The Ethernet link will remain down until the TX capacity reaches this threshold. The default is 0 Mbps. This setting should be greater than the *TX Capacity Low Threshold* to avoid flutter and multiple OSPF convergences.

RX Capacity Low Threshold This is the minimum allowable RX capacity; if the RX capacity goes below this threshold, the Ethernet link will be dropped. The default is 0 Mbps.

RX Capacity High Threshold This is the RX capacity required before a dropped link can be declared to be operational again. The Ethernet link will remain down until the RX capacity reaches this threshold. The default is 0 Mbps. This setting should be greater than the *RX Capacity Low Threshold* to avoid flutter and multiple OSPF convergences.

Low Threshold Timer This is the number of continuous seconds that the radio must remain under the minimum TX or RX capacity threshold before the link is dropped. If set to 0, then as soon as capacity drops below a set limit, the Ethernet link will be dropped. The default is 0 seconds.

High Threshold Timer This is the number of continuous seconds that the radio must remain above the maximum TX or RX capacity threshold before the link is declared operational again. The default is 0 seconds.

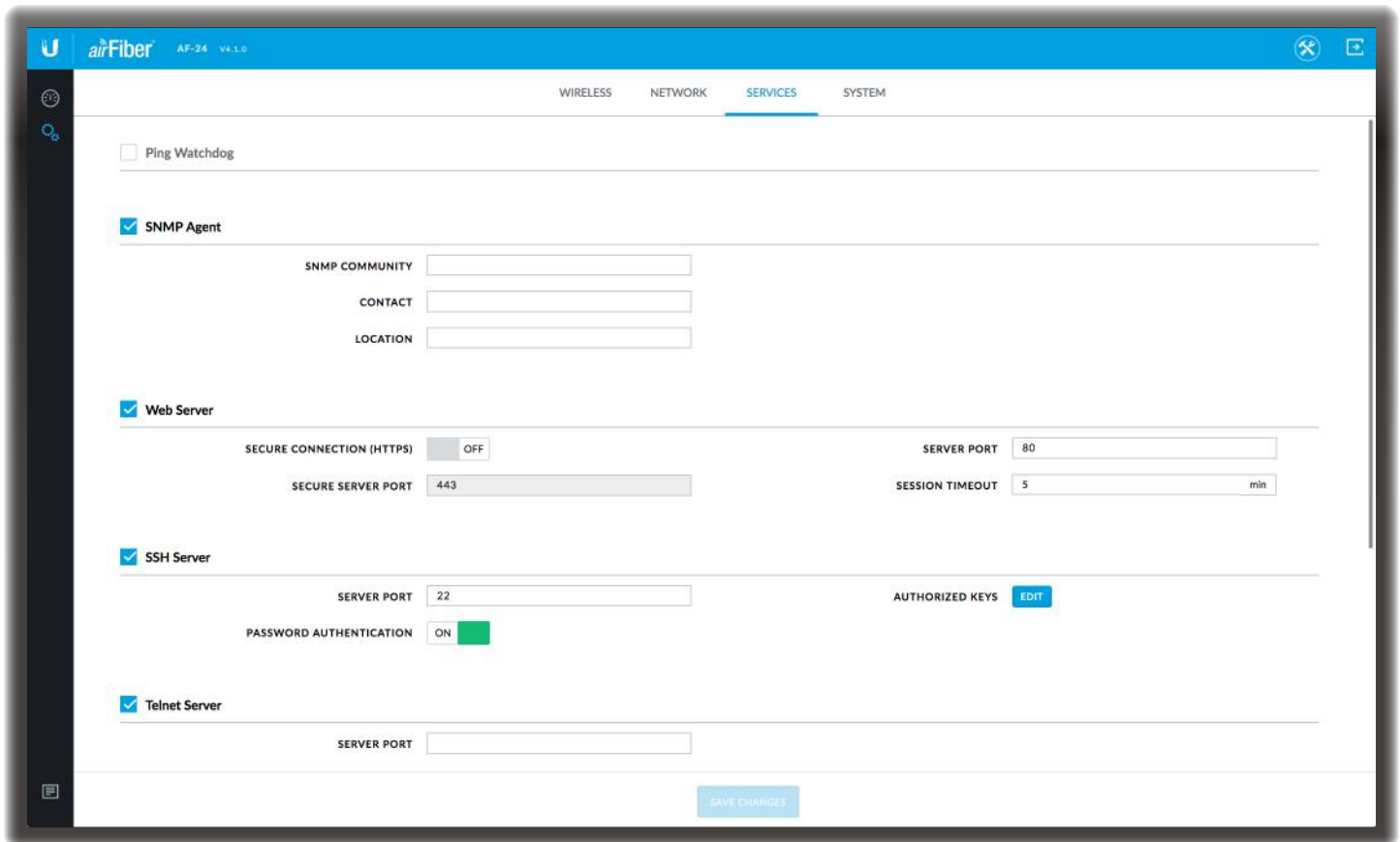

Chapter 7: Services Tab

The *Services* tab configures system management services: *Ping Watchdog*, *SNMP Agent*, *Web Server*, *SSH Server*, *Telnet Server*, *NTP Client*, *Dynamic DNS*, *System Log*, and *Device Discovery*.

Ping Watchdog

Ping Watchdog sets the airFiber AF-24 to continuously ping a user-defined IP address (it can be the internet gateway, for example). If it is unable to ping under the user-defined constraints, then the airFiber AF-24 will automatically reboot. This option creates a kind of “fail-proof” mechanism.

Ping Watchdog is dedicated to continuous monitoring of the specific connection to the remote host using the *Ping* tool. The *Ping* tool works by sending ICMP echo request packets to the target host and listening for ICMP echo response replies. If the defined number of replies is not received, the tool reboots the airFiber AF-24.

Ping Watchdog Enables use of *Ping Watchdog*.

- **IP Address To Ping** Specify the IP address of the target host to be monitored by *Ping Watchdog*.
- **Ping Interval** Specify the time interval (in seconds) between the ICMP echo requests that are sent by *Ping Watchdog*. The default value is 300 seconds.
- **Startup Delay** Specify the initial time delay (in seconds) until the first ICMP echo requests are sent by *Ping Watchdog*. The default value is 300 seconds.
The *Startup Delay* value should be at least 60 seconds as the network interface and wireless connection initialization takes a considerable amount of time if the airFiber AF-24 is rebooted.
- **Failure Count to Reboot** Specify the number of ICMP echo response replies. If the specified number of ICMP echo response packets is not received continuously, *Ping Watchdog* will reboot the airFiber AF-24. The default value is 3.
- **Save Support Info** This generates a support information file.

SNMP Agent

Simple Network Monitor Protocol (SNMP) is an application layer protocol that facilitates the exchange of management information between network devices. Network administrators use SNMP to monitor network-attached devices for issues that warrant attention.

The airFiber AF-24 contains an *SNMP Agent*, which does the following:

- Provides an interface for device monitoring using SNMP
- Communicates with SNMP management applications for network provisioning
- Allows network administrators to monitor network performance and troubleshoot network problems

For the purpose of equipment identification, configure the *SNMP Agent* with contact and location information:

SNMP Agent Enables the *SNMP Agent*.

- **SNMP Community** Specify the SNMP community string. It is required to authenticate access to Management Information Base (MIB) objects and functions as an embedded password. The airFiber AF-24 also supports a read-only community string; authorized management stations have read access to all the objects in the MIB except the community strings, but do not have write access. The airFiber AF-24 supports SNMP v1. The default SNMP Community is *public*.
- **Contact** Specify the contact who should be notified in case of emergency.
- **Location** Specify the physical location of the airFiber AF-24.

Web Server

The following *Web Server* parameters can be set:

Secure Connection (HTTPS) If enabled, the *Web Server* uses secure HTTPS mode.

- **Secure Server Port** If secure HTTPS mode is used, specify the TCP/IP port of the *Web Server*.

Server Port If HTTP mode is used, specify the TCP/IP port of the *Web Server*.

Session Timeout Specifies the maximum timeout before the session expires. Once a session expires, you must log in again using the username and password.

SSH Server

The following *SSH Server* parameters can be set:

SSH Server Enables SSH access to the airFiber AF-24.

- **Server Port** Specify the TCP/IP port of the *SSH Server*.

- **Password Authentication** If enabled, you must authenticate using administrator credentials to grant SSH access to the airFiber AF-24; otherwise, an authorized key is required.
- **Authorized Keys** Click **Edit** to import a public key file for SSH access to the airFiber AF-24 instead of using an admin password.

- **Upload** Click **Upload** to locate the new key file. Select the file and click **Open**.
- **Enabled** Enables the specific key. All the added keys are saved in the system configuration file; however, only the enabled keys are active on the airFiber AF-24.
- **Type** Displays the type of key.
- **Key** Displays the key.
- **Comment** You can enter a brief description of the key.
- **Action** You have the following options:
 - **Add** Adds a public key file.
 - **Edit** Make changes to a public key file. Click **Save** to save your changes.
 - **Del** Deletes a public key file.
- **Ok** Saves your changes.
- **Cancel** Discards your changes.

Telnet Server

The following *Telnet Server* parameters can be set:

Telnet Server This option activates Telnet access to the airFiber AF-24.

- **Server Port** Specify the TCP/IP port of the *Telnet Server*.

NTP Client

Network Time Protocol (NTP) is a protocol for synchronizing the clocks of computer systems over packet-switched, variable-latency data networks. You can use it to set the system time on the airFiber AF-24. If the *Log* option is enabled, then the system time is reported next to every log entry that registers a system event.

NTP Client Enables the airFiber AF-24 to obtain the system time from a time server on the internet.

- **NTP Server** Specify the IP address or domain name of the NTP server.

Dynamic DNS

Domain Name System (DNS) translates domain names to IP addresses; Each DNS server on the internet holds these mappings in its respective DNS database. Dynamic Domain Name System (DDNS) is a network service that notifies the DNS server in real time of any changes in the airFiber AF-24's IP settings. Even if the airFiber AF-24's IP address changes, you can still access the airFiber AF-24 through its domain name.

Dynamic DNS If enabled, the airFiber AF-24 allows communications with the DDNS server.

- **Host Name** Enter the host name of the DDNS server.
- **Username** Enter the user name of the DDNS account.
- **Password** Enter the password of the DDNS account.
- **Show** Check the box to display the password characters.

System Log

System Log This option enables the registration routine of system log (syslog) messages. By default it is disabled.

- **Remote Log** Enables the syslog remote sending function. System log messages are sent to a remote server, which is specified in the *Remote Log IP Address* and *Remote Log Port* fields.
 - **Remote Log IP Address** The host IP address that receives syslog messages. Properly configure the remote host to receive syslog protocol messages.
 - **Remote Log Port** The TCP/IP port that receives syslog messages. *514* is the default port for the commonly used system message logging utilities.

Every logged message contains at least a system time and host name. Usually a specific service name that generates the system event is also specified within the message. Messages from different services have different contexts and different levels of detail. Usually error, warning, or informational system service messages are reported; however, more detailed debug level messages can also be reported. The more detailed the system messages reported, the greater the volume of log messages generated.

Device Discovery

Discovery Enables device discovery, so the airFiber AF-24 can be discovered by other Ubiquiti devices through the *Discovery* tool.

CDP Enables Cisco Discovery Protocol (CDP) communications, so the airFiber AF-24 can send out CDP packets to share its information.

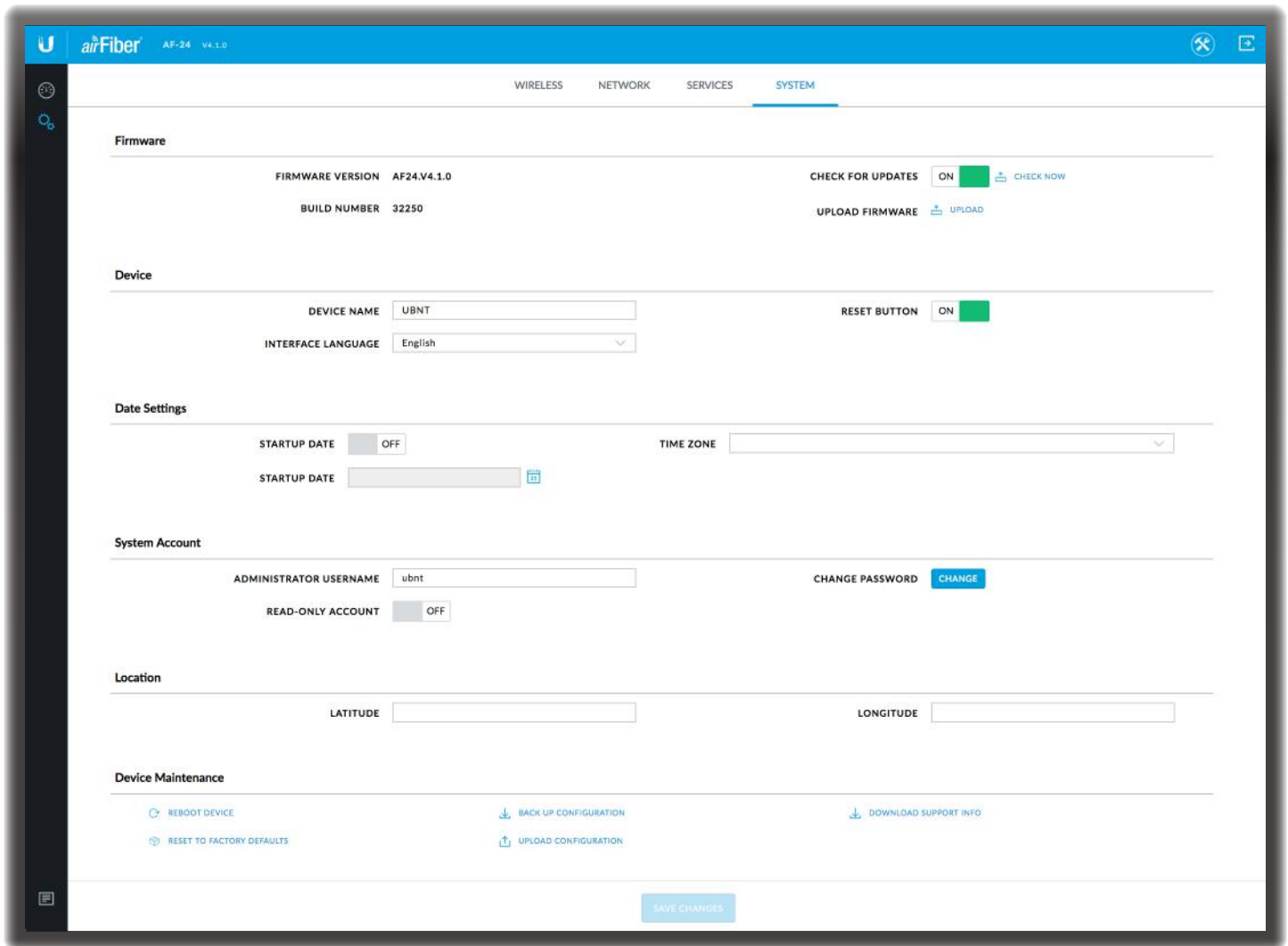

Chapter 8: System Tab

The *System* tab contains administrative options. This page enables the administrator to upload new firmware, edit the device and date settings, configure the administrator account, set the device's location, reboot the airFiber AF-24, reset it to factory default, back up or update the configuration, and download support information.

Firmware Update

The controls in this section manage firmware maintenance.



Firmware Version Displays the current firmware version.

Build Number Displays the build number of the firmware version.

Check for Updates By default, the firmware automatically checks for updates. To manually check for an update, click **Check Now**.

Upload Firmware Click this button to update the airFiber AF-24 with new firmware.

The airFiber AF-24 firmware update is compatible with all configuration settings. The system configuration is preserved while the AF-24 is updated with a new firmware version. However, we recommend backing up your current system configuration before updating the firmware.

This is a three-step procedure:

1. Click **Choose File** to locate the new firmware file. Select the file and click **Open**.
2. Click **Upload** to upload the new firmware to the airFiber AF-24.
3. The Uploaded Firmware Version is displayed. Click **Update** to confirm.

If the firmware update is in process, you can close the firmware update window, but this does not cancel the firmware update. Please be patient, as the firmware update routine can take three to seven minutes. You cannot access the airFiber AF-24 until the firmware update routine is completed.

! WARNING: Do not power off, do not reboot, and do not disconnect the airFiber AF-24 from the power supply during the firmware update process as these actions will damage the airFiber AF-24!

Device

The Device Name (host name) is the system-wide device identifier. The SNMP agent reports it to authorized management stations. The Device Name will be used in popular router operating systems, registration screens, and discovery tools.

The screenshot shows the 'Device' configuration page. It includes a 'DEVICE NAME' field with the value 'UBNT', a 'RESET BUTTON' toggle set to 'ON', and an 'INTERFACE LANGUAGE' dropdown menu set to 'English'.

Device Name Specifies the host name.

Interface Language Allows you to select the language displayed in the web management interface. *English* is the default language.

Reset Button To allow use of the airFiber AF-24's physical reset button, check the box. To prevent an accidental reset to default settings, uncheck the box.

Note: You can reset the airFiber AF-24 to default settings via the airFiber Configuration Interface. Go to the *System* tab > *Reset to Defaults*.

Date Settings

The screenshot shows the 'Date Settings' page. It includes a 'STARTUP DATE' toggle set to 'OFF', a 'TIME ZONE' dropdown menu, and a 'STARTUP DATE' field with a calendar icon.

Time Zone Specifies the time zone in relation to Greenwich Mean Time (GMT).

Startup Date When enabled, you are able to change the airFiber AF-24's startup date.

- **Startup Date** Specifies the airFiber AF-24's startup date. Click the **Calendar** icon or manually enter the date in the following format: 2-digit month/2-digit day/4-digit year. For example, for April 5, 2012, enter **04/05/2012** in the field.

System Accounts

You can change the administrator password to protect your device from unauthorized changes. We recommend that you change the default administrator password when initially configuring the device.

The screenshot shows the 'System Account' configuration page. It includes an 'ADMINISTRATOR USERNAME' field with the value 'ubnt', a 'CHANGE PASSWORD' button labeled 'CHANGE', and a 'READ-ONLY ACCOUNT' toggle set to 'OFF'.

Administrator Username Specifies the name of the administrator. The maximum length is 31 characters.

Change Password Click **Change** to change the administrator password. The maximum password length is 64 characters

- **Current Password** Enter the current password for the administrator account. It is required to change the *Password* or *Administrator Username*.
- **New Password** Enter the new password for the administrator account.
- **Verify New Password** Re-enter the new password for the administrator account.

Note: . If you upgrade to v4.0 or above from an earlier version, use your old password (maximum eight characters) for your first login. Then, change the password as needed (maximum 32 characters). To downgrade from v4.0 or above to an earlier version, first ensure that the password is eight characters or less in length; otherwise, login will fail (to recover, reset the radio to factory defaults).

As you type the new password, the *Password Strength* indicates the relative strength from orange (least secure) to blue (most secure).

Read-Only Account Check the box to enable the read-only account, which can only view the *Dashboard*. Configure the username and password to protect your device from unauthorized changes.

- **Read-Only User Name** Specifies the name of the system user.
- **Change Password** Click **Change** to change the read-only account password.
 - **New Password** Enter the new password for the read-only account.
 - **Verify New Password** Re-enter the new password for the read-only account.

As you type the new password, the *Password Strength* indicates the relative strength from orange (least secure) to blue (most secure).

Location

After the on-board GPS determines the location of the airFiber AF-24, its latitude and longitude are displayed. If the GPS does not have a fix on its location, then “Searching for Satellites” will be displayed.



Latitude The latitude of the airFiber AF-24’s location is displayed.

Longitude The longitude of the airFiber AF-24’s location is displayed.

Device Maintenance

The controls in this section manage the airFiber AF-24 maintenance routines.



Reboot Device Initiates a full reboot cycle of the airFiber AF-24. Reboot is the same as the hardware reboot, which is similar to the power-off and power-on cycle. The system configuration stays the same after the reboot cycle completes. Any changes that have not been applied are lost.

After the airFiber AF-24 reboots, the settings of the new configuration are displayed in the *Wireless*, *Network*, *Advanced*, *Services*, and *System* tabs of the airFiber Configuration Interface.

Reset to Factory Defaults Click this option to reset the airFiber AF-24 to the factory default settings. This option will reboot the airFiber AF-24, and all factory default settings will be restored. We recommend that you back up your current system configuration before resetting the airFiber AF-24 to its defaults.

Back Up Configuration Click this option to download the current system configuration file.

The airFiber AF-24 configuration is stored in a plain text file (.cfg file). You can back up, restore, or update the system configuration file:

Upload Configuration Click this option to locate the new configuration file. Select the file and click **Open**. We recommend that you back up your current system configuration before uploading the new configuration.

Download Support Info This generates a support information file that the Ubiquiti support engineers can use when providing customer support. This file only needs to be generated at their request.

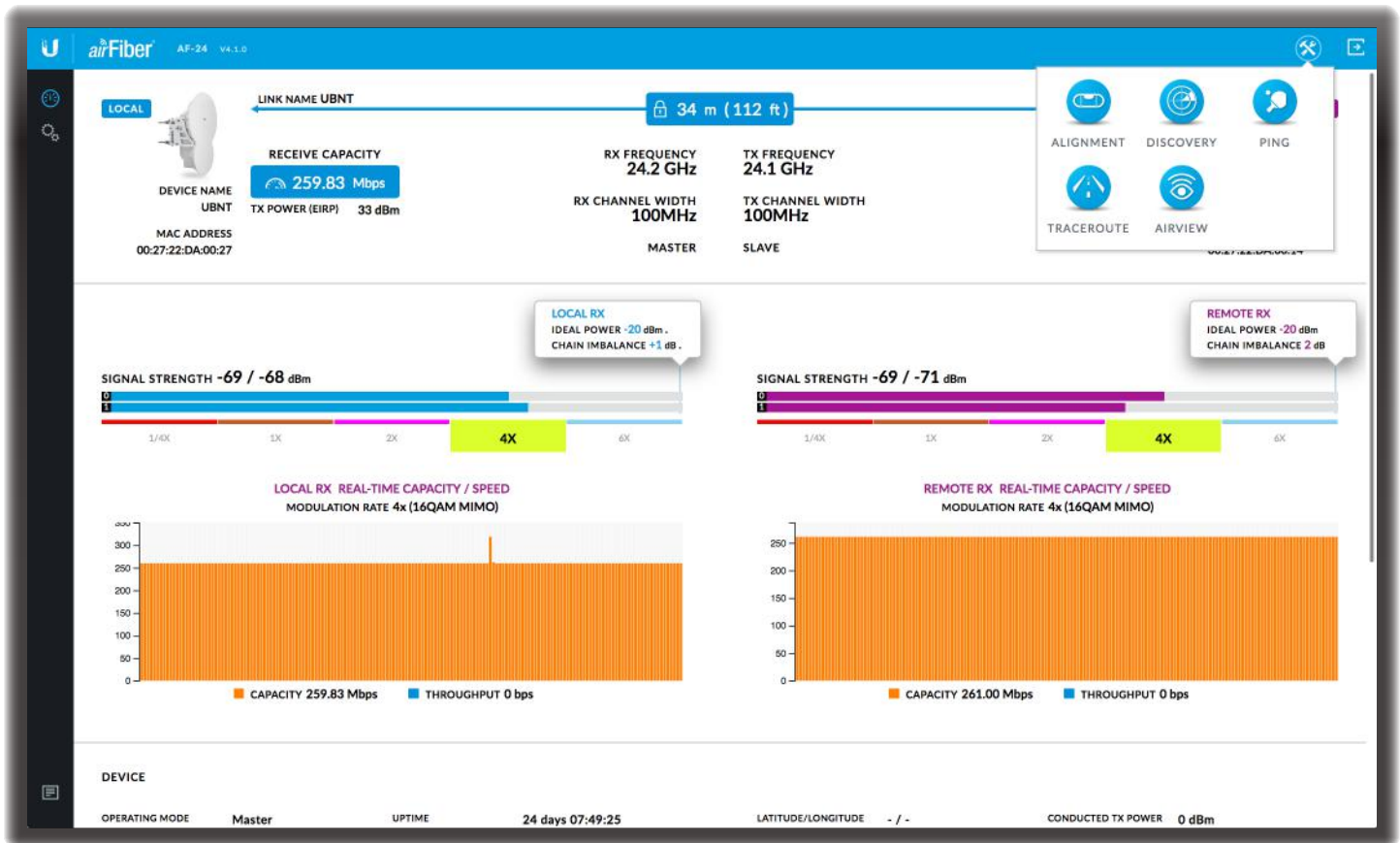

Chapter 9: Tools

Each page of the airFiber Configuration Interface contains the  icon, which provides links to tools and information. The icon is found near the upper-right corner of the window.

When you click  the following list of network administration and monitoring tools is displayed:

- [“Align Antenna” on page 45](#)
- [“Discovery” on page 46](#)
- [“Ping” on page 46](#)
- [“Traceroute” on page 46](#)
- [“airView” on page 47](#)

Align Antenna

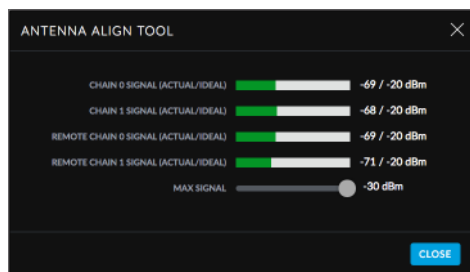

Use the *Align Antenna* tool to point and optimize the antenna in the direction of maximum link signal. (See [“Using the airFiber Configuration Interface” on page 15](#) for more details.) The *Antenna Alignment* window reloads every 250 milliseconds.

Chain 0/1 Signal (Actual/Ideal) Displays the actual power level (bar graph and first number) and ideal power level (second number) in dBm of the received signal for chain 0 and chain 1.

Changing the *RX Gain* on the *Wireless* tab does not affect the *Signal Strength* values displayed on the *Antenna Alignment* window. However, if “Overload” is displayed to indicate overload condition, decrease the *RX Gain*. Refer to [“RX Gain” on page 30](#) for more details about *RX Gain* and overload condition.

Remote Chain 0/1 Signal (Actual/Ideal) Displays the actual power level (bar graph and first number) and ideal power level (second number) in dBm of the received signal for chain 0 and chain 1 of the remote airFiber radio.

Max Signal Displays the maximum signal strength in dBm. To adjust the range of the *Max Signal* meter, use the slider control. If you reduce the range, the bar graphs will be more sensitive to signal fluctuations, indicating the offset of the maximum indicator value and the scale itself.

Discovery

The *Device Discovery* tool searches for all Ubiquiti devices on your network. The *Search* field automatically filters devices containing specified names or numbers as you enter them.

MAC ADDRESS	DEVICE NAME	MODE	SSID	PRODUCT	FIRMWARE	IP ADDRESS
82:2A:A8:CE:CE:42	rs1s AF5xhd	Slave	ubnt	AF-5XHD	v1.1.1-BETA2	10.8.10.133
44:D9:E7:06:0F:D8	UBNT EdgeSwitch	-	--	ES-48-750W	v1	10.8.8.108
7A:8A:20:5F:0B:82	AirFiber 5XHD	Master	ubnt	AF-5XHD	v1.2.0-ALB	10.8.9.141
82:2A:A8:CE:CE:92	AF5hd-41	Slave	ubnt	AF-5XHD	v1.3.0-blehttp	10.8.6.125
82:2A:A8:CE:F7:99	APRIL-5XHD_CPE4	Master	ubnt	AF-5XHD	v1.3.1-ALB	10.8.6.94
82:2A:A8:CE:F7:89	AirFiber 5XHD	Slave	ubnt	AF-5XHD	v1.1.1-SPECAN	10.8.11.213
7A:8A:20:5F:0B:69	AirFiber 5XHD	Master	ubnt	AF-5XHD	v1.1.0-beta2	10.8.9.153
04:18:D6:E3:2F:5B	1300 AF2X	Slave	UBNT	airFiber 2X	v4.0.2	10.8.9.123
82:2A:A8:CE:CE:87	AirFiber 5XHD	Master	ubnt	AF-5XHD	v1.1.1-BETA2	10.8.9.171
04:18:D6:E3:2F:73	r1s1_m2x	Master	UBNT	airFiber 2X	v4.1.0-dev	10.8.9.9
7B:8A:20:5F:25:55	AirFiber LTU	Slave	ubnt11	AF-LTU	v1.1.1 DEV	10.8.9.178
04:18:D6:E3:0B:CF	r1s3_s5x	Slave	UBNT	airFiber 5X	v4.1.0-beta2	10.8.10.16
04:18:D6:E3:0D:4D	UBNT	Slave	UBNT	airFiber 4X	v4.0-beta8	10.8.11.111
04:18:D6:E3:0D:41	1250-AP3X	Slave	UBNT	airFiber 5X	v4.0.2	10.8.9.140
04:18:D6:E3:D2:50	UBNT	Master	UBNT	airFiber 5X	v4.1.0-dev	10.8.9.175
FD:9F:C2:0E:DE:3F	UBNT EdgeSwitch	-	--	ES-48-750W	v1.7.1	10.8.9.158
24:A4:3C:38:1A:F8	r3s1top	Master	UBNT	airFiber 5	v4.1.0-dev	10.8.10.58
EC:13:82:61:9E:8E	Netonix Switch	-	--	WS-12-250-AC	v1.4.7	10.8.9.61
24:A4:3C:38:49:CE	UBNT	Slave	UBNT	airFiber 5	v4.1.0-dev	10.8.8.136
04:18:D6:83:4F:72	r1s1	-	--	ES-48-750W	v1.7.1	10.8.9.85
04:18:D6:E3:D6:D6	UBNT	Slave	UBNT	airFiber 5X	v4.1.0-dev	10.8.9.176
FD:9F:C2:0B:03:4	UBNT EdgeSwitch	-	--	ES-12F	v1.7.0	10.8.11.51
04:18:D6:E3:E5:38	r2s3_m11x	Master	UBNT	airFiber 11FX	v4.1.0-dev	10.8.10.67
44:D9:E7:06:76:EE	UBNT EdgeSwitch	-	--	ES-24-Lite	v1	10.8.8.160
04:18:D6:E3:0D:8D	UBNT	Slave	UBNT	airFiber 5X	v4.1.0-dev	10.8.9.241

It reports the *MAC Address* (except for airFiber devices), *Device Name*, *Mode*, *SSID*, *Product* type, *Firmware* version, and *IP Address* for each Ubiquiti device. To access a device configuration through its web management interface, click the device's IP address.

To refresh the window, click **Scan**.

Ping

You can ping other devices on the network directly from the airFiber AF-24. The *Ping* tool uses ICMP packets to check the preliminary link quality and packet latency estimation between two network devices.

NETWORK PING

SELECT DESTINATION IP: Specify Manually

PACKET COUNT:

PACKET SIZE:

HOST	TIME	TTL	RESULTS
No data available			

PACKET LOSS: 0%
0 OF 0 PACKETS RECEIVED

MIN: 0 ms

AVG: 0.00 ms

MAX: 0 ms

START

Network Ping

Select Destination IP You have two options:

- Select a remote system IP from the drop-down list, which is generated automatically.
- Select **specify manually** and enter the IP address in the field displayed below.

Packet Count Enter the number of packets to send for the ping test.

Packet Size Specify the size of the packet.

Start Click this button to start the test.

Packet loss statistics and latency time evaluation are displayed after the test is completed.

Traceroute

The *Traceroute* tool traces the hops from the airFiber AF-24 to a specified outgoing IP address. Use this tool to find the route taken by ICMP packets across the network to the destination host.

TRACEROUTE

DESTINATION HOST:

RESOLVE IP ADDRESSES:

#	HOST	IP	RESPONSE
No data available			

START

Destination Host Enter the IP address of the destination host.

Resolve IP Addresses Select this option to resolve the IP addresses symbolically rather than numerically.

Start Click this button to start the test.

Responses are displayed after the test is completed.

airView

Use the airView Spectrum Analyzer to analyze the noise environment of the radio spectrum and intelligently select the optimal frequency to install a PtP airFiber AF-24 link.

There are two system requirements for the airView Spectrum Analyzer:

- Your system is connected to the device via Ethernet. Launching airView will terminate all wireless connections on the device.
- Java Runtime Environment 1.6 (or above) is required on your client machine to use airView.

On first use, the following window appears.

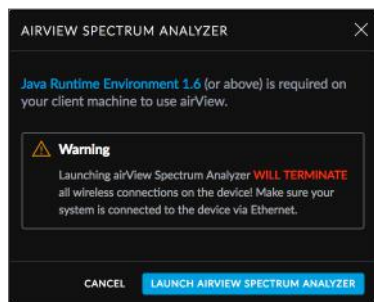

- **Launch airView** Click **Launch airView** to download the Java Network Launch Protocol (jnlp) file and complete the launch of airView.

 **Note:** Depending on your browser settings, you may also see additional prompts; continue through these as needed to finish launching airView.

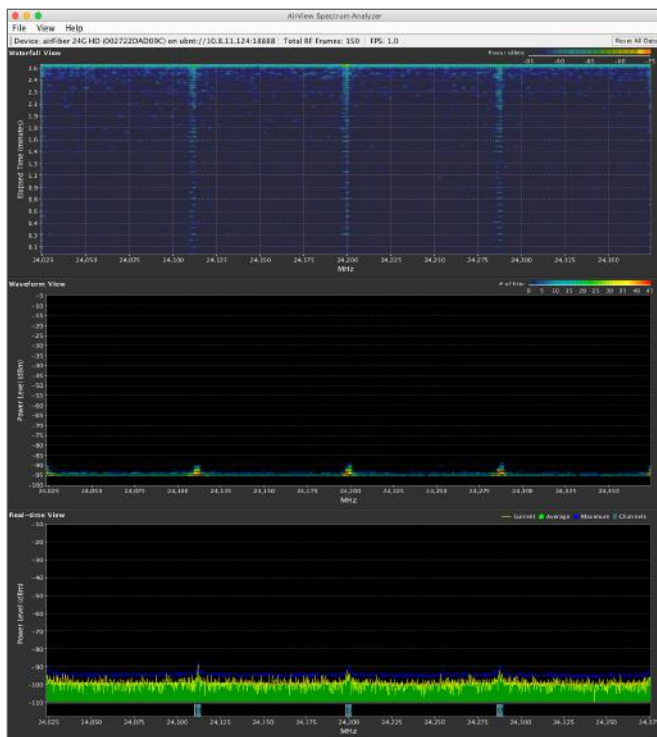

Main View

Device: airFiber 24G HD (002722DAD09C) on ubnt://10.8.11.124:18888 Total RF Frames: 150 FPS: 1.0 Reset All Data

Device Displays the device name, MAC (Media Access Control) address, and IP address of the device running airView.

Total RF Frames Displays the total number of Radio Frequency (RF) frames gathered since the start of the airView session or since the *Reset All Data* button was last clicked.

FPS Displays the total number of frames per second (FPS) gathered since the start of the airView session or since the *Reset All Data* button was last clicked. The wider the interval amplitude, the fewer the FPS will be gathered.

Reset All Data Click to reset all gathered data. Use this option to analyze the spectrum for another location or address.

File Menu

Click **Exit** to end the airView session.

View Menu

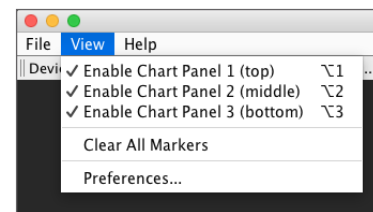

Enable Chart Panel 1 (top) Displays the Waterfall or Channel Usage chart in Chart Panel 1, depending on which option you have selected in *Preferences*. This time-based graph shows the aggregate energy collected or channel usage for each frequency since the start of the airView session.

Enable Chart Panel 2 (middle) Displays the Waveform chart in Chart Panel 2. This time-based graph shows the RF signature of the noise environment since the start of the airView session. The energy color designates its amplitude. Cooler colors represent lower energy levels (with blue representing the lowest levels) in that frequency bin, and warmer colors (yellow, orange, or red) represent higher energy levels in that frequency bin.

Enable Chart Panel 3 (bottom) Displays the Real-time chart (traditional spectrum analyzer) in Chart Panel 3. Energy (in dBm) is shown in real time as a function of frequency.

 **Note:** Energy is defined as the power ratio in decibels (dB) of the measured power referenced to one milliwatt (mW).

Clear All Markers Resets all previously assigned markers. Markers are assigned by clicking a point, which corresponds with a frequency on the Real-time chart.

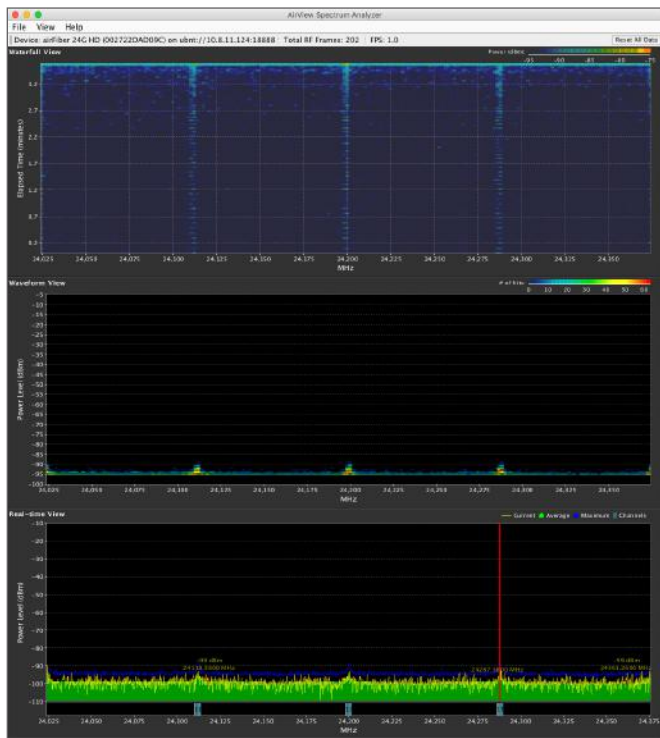

airView Window with Marker

Preferences Changes airView settings, such as enabling or disabling charts and traces, or specifying the frequency interval.

Preferences

Select **View > Preferences** to display the *Preferences - airView Spectrum Analyzer* window.

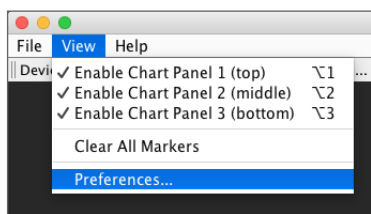

The *Preferences - airView Spectrum Analyzer* window provides options on two tabs: *Charts* and *Realtime Traces*.

Charts

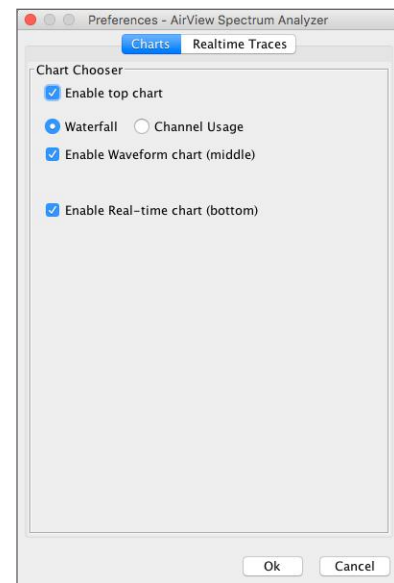

Enable top chart Check the box to enable the top chart. Select the desired chart to display in the top chart panel on the main view. There are two options:

- **Waterfall** This time-based graph shows the aggregate energy collected for each frequency since the start of the airView session. The energy color designates its amplitude. Cooler colors represent lower energy levels (with blue representing the lowest levels) in that frequency bin, and warmer colors (yellow, orange, or red) represent higher energy levels in that frequency bin. The Waterfall View's legend (top-right corner) provides a numerical guide associating the various colors to power levels (in dBm). The low end of that legend (left) is always adjusted to the calculated noise floor, and the high end (right) is set to the highest detected power level since the start of the airView session.
- **Channel Usage** Displays each Wi-Fi channel's relative "crowdedness" as a percentage. The airView Spectrum Analyzer calculates this percentage by analyzing both the popularity and strength of RF energy in that channel since the start of the airView session.

Enable Waveform chart (middle) Check the box to enable the middle chart. This time-based graph shows the RF signature of the noise environment since the start of the airView session. The energy color designates its amplitude. Cooler colors represent lower energy levels (with blue representing the lowest levels) in that frequency bin, and warmer colors (yellow, orange, or red) represent higher energy levels in that frequency bin.

The spectral view over time will display the steady-state RF energy signature of a given environment.

Enable Real-time chart (bottom) Check the box to enable the bottom chart. This graph displays a traditional spectrum analyzer in which energy (in dBm) is shown in real time as a function of frequency. There are three traces in this view:

- **Current** (Yellow) Shows the real-time energy seen by the device as a function of frequency.
- **Average** (Green) Shows the running average energy across frequency.
- **Maximum** (Blue) Shows updates and maximum power levels across frequency.

Realtime Traces

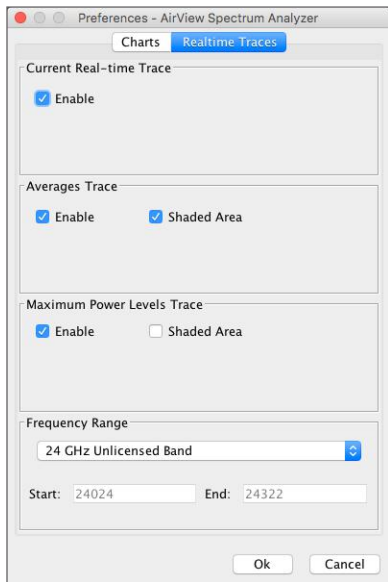

The following settings apply only to the *Real-time* chart:

Current Real-time Trace Check the *Enable* box to enable the real-time trace. When enabled, the yellow outline on the *Real-time* chart represents the real-time power level of each frequency. The refresh speed depends on the FPS.

Averages Trace Check the *Enable* box to enable the averages trace. When enabled, the averages trace is represented by the green area on the *Real-time* chart, which displays the average received power level data since the start of the airView session. To enable a shaded green area, check the *Shaded Area* box. To display only a green outline without the shaded area, uncheck the *Shaded Area* box.

Maximum Power Levels Trace Check the *Enable* box to enable the maximum power trace. When enabled, the maximum power trace is represented by the blue area on the *Real-time* chart, which displays the maximum received power level data since the start of the airView session. To enable a shaded blue area, check the *Shaded Area* box. To display only a blue outline without the shaded area, uncheck the *Shaded Area* box.

Frequency Range Select the amplitude of the frequency interval to be scanned from the *Frequency Range* drop-down list. Available frequencies are device-dependent. There are pre-defined ranges for the most popular bands. You can enter a custom range; select **Custom Range** from the *Frequency Range* drop-down list and enter the desired values in the *Start* and *End* fields.

Help

Click **About** to view the version and build number of the airView Spectrum Analyzer.

Log

When logging is enabled, click the *Log* icon  at the bottom left corner of the page to open the *System Log* window, which provides a record of events on the system.

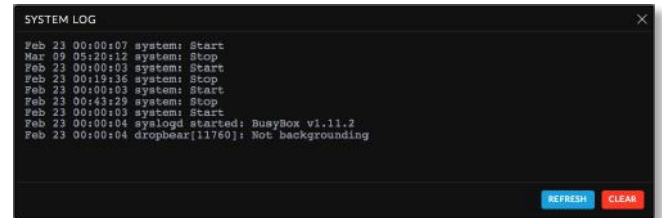

By default, logging is not enabled; see **[“System Log” on page 39](#)** for information on how to enable logging.

Click **Refresh** to update the display with the most recent information. To clear the system log, click **Clear**, and then click **Yes** to verify.

Appendix A: Specifications

airFiber AF-24	
Dimensions	649 x 426 x 303 mm (25.55 x 16.77 x 11.93 in)
Weight	10.5 kg (23.15 lb) (Mount Included)
Operating Frequency	24.05 – 24.25 GHz
Max. Power Consumption	< 50W
Power Supply	50V, 1.2A PoE GigE Adapter (Included)
Power Method	Passive Power over Ethernet (42-58VDC)
Certifications	CE, FCC, IC
Wind Loading	480 N @ 200 km/hr (108 lbf @ 125 mph)
Wind Survivability	200 km/hr (125 mph)
Mounting	Pole Mount Kit (Included)
Operating Temperature	-40 to 55°C (-40 to 131° F)
LEDs	(8) Status LEDs: Data Port Speed Data Port Link/Activity Configuration Port Speed Configuration Port Link/Activity GPS Synchronization Modulation Mode Master/Slave RF Status (1) Two-Digit LED Display Calibrated in dBm
Button	Reset
Interface	
Data Port	(1) 10/100/1000 Ethernet Port
Configuration Port	(1) 10/100 Ethernet Port
Auxiliary Port	(1) RJ-12, Alignment Tone Port
System	
Maximum Throughput	1.4+ Gbps
Maximum Range	13+ km (8+ mi)
Packets per Second	> 1 Million
Encryption	128-Bit AES
Forward Error Correction	164/205
Cyclic Prefix	1/16 Fixed
Uplink/Downlink Ratio	50% Fixed

AF-24 Receive Sensitivity			
Modulation	Sensitivity	FDD Capacity*	TDD Capacity*
64QAM	-66 dBm	1500 Mbps	760 Mbps
16QAM	-72 dBm	1000 Mbps	507 Mbps
QPSK MIMO	-78 dBm	500 Mbps	253 Mbps
QPSK SISO	-80 dBm	250 Mbps	127 Mbps
¼x QPSK SISO	-87 dBm	62.5 Mbps	31.7 Mbps

* FDD = (2) 100 MHz channels and TDD = (1) 100 MHz channel

AF-24 Radio Frequency	
GPS	GPS Clock Synchronization
Transceiver	
EIRP	~33 dBm (FCC/IC), ~20 dBm (CE), ~40 dBm (Other Regions)
Frequency Accuracy	±2.5 ppm without GPS Synchronization ± 0.2 ppm with GPS Synchronization
Channel Bandwidth	100 MHz
Operating Channels	24.1 GHz, 24.2 GHz
Modulation	64QAM MIMO 16QAM MIMO QPSK MIMO QPSK SISO ¼x QPSK SISO
Integrated Split Antenna	
TX Gain	33 dBi
RX Gain	38 dBi
Beamwidth	< 3.5°
Front-to-Back Ratio	70 dB
Polarity	Dual-Slant Polarization
Cross-Polarity Isolation	> 28 dB

AF-24 Capacity (Mbps)		
Rate	Modulation	100 MHz Channel Width*
6x	64QAM MIMO	1500.0
4x	16QAM MIMO	1000.0
2x	QPSK MIMO	500.0
1x	QPSK SISO	250.0
¼x	¼ QPSK SISO	62.5

* Aggregate capacity in Full-Duplex mode

airFiber AF-24HD	
Dimensions	593 x 768 x 370 mm (23.35 x 30.24 x 14.57 in)
Weight	17.3 kg (38.14 lb) (Mount Included)
Operating Frequency	24.05 – 24.25 GHz
Max. Power Consumption	< 50W
Power Supply	50V, 1.2A PoE GigE Adapter (Included)
Power Method	Passive Power over Ethernet (42-58VDC)
Certifications	CE, FCC, IC
Wind Loading	770 N @ 200 km/hr (170 lbf @ 125 mph)
Wind Survivability	200 km/hr (125 mph)
Mounting	Pole Mount Kit (Included)
Operating Temperature	-40 to 55°C (-40 to 131° F)
LEDs	(8) Status LEDs: Data Port Speed Data Port Link/Activity Configuration Port Speed Configuration Port Link/Activity GPS Synchronization Modulation Mode Master/Slave RF Status (1) Two-Digit LED Display Calibrated in dBm
Button	Reset
Interface	
Data Port	(1) 10/100/1000 Ethernet Port
Configuration Port	(1) 10/100 Ethernet Port
Auxiliary Port	(1) RJ-12, Alignment Tone Port
System	
Maximum Throughput	1.4+ Gbps
Maximum Range	13+ km (8+ mi)
Packets per Second	> 1 Million
Encryption	128-Bit AES
Uplink/Downlink Ratio	50% Fixed

AF-24HD Receive Sensitivity			
Modulation	Sensitivity	FDD Capacity*	TDD Capacity*
256QAM	-60 dBm	2000 Mbps	1024 Mbps
64QAM	-66 dBm	1500 Mbps	760 Mbps
16QAM	-72 dBm	1000 Mbps	507 Mbps
QPSK MIMO	-78 dBm	500 Mbps	253 Mbps
QPSK SISO	-80 dBm	250 Mbps	127 Mbps
¼x QPSK SISO	-87 dBm	62.5 Mbps	31.7 Mbps

* FDD = (2) 100 MHz channels and TDD = (1) 100 MHz channel

AF-24HD Radio Frequency	
GPS	GPS Clock Synchronization
Transceiver	
EIRP	~33 dBm (FCC/IC), ~20 dBm (CE), ~40 dBm (Other Regions)
Frequency Accuracy	±2.5 ppm without GPS Synchronization ± 0.2 ppm with GPS Synchronization
Channel Bandwidth	100 MHz
Operating Channels	24.1 GHz, 24.2 GHz
Modulation	256QAM MIMO 64QAM MIMO 16QAM MIMO QPSK MIMO QPSK SISO ¼x QPSK SISO
Integrated Split Antenna	
TX Gain	33 dBi
RX Gain	40 dBi
Beamwidth	< 3.5°
Front-to-Back Ratio	70 dB
Polarity	Dual-Slant Polarization
Cross-Polarity Isolation	> 28 dB

AF-24HD Capacity (Mbps)		
Rate	Modulation	100 MHz Channel Width*
8x	256QAM MIMO	2000.0
6x	64QAM MIMO	1500.0
4x	16QAM MIMO	1000.0
2x	QPSK MIMO	500.0
1x	QPSK SISO	250.0
¼x	¼ QPSK SISO	62.5

* Aggregate capacity in Full-Duplex mode

Appendix B: Safety Notices

1. Read, follow, and keep these instructions.
2. Heed all warnings.
3. Only use attachments/accessories specified by the manufacturer.

 **WARNING:** Do not use this product in location that can be submerged by water.

 **WARNING:** Avoid using this product during an electrical storm. There may be a remote risk of electric shock from lightning.

Electrical Safety Information

1. Compliance is required with respect to voltage, frequency, and current requirements indicated on the manufacturer's label. Connection to a different power source than those specified may result in improper operation, damage to the equipment or pose a fire hazard if the limitations are not followed.
2. There are no operator serviceable parts inside this equipment. Service should be provided only by a qualified service technician.
3. This equipment is provided with a detachable power cord which has an integral safety ground wire intended for connection to a grounded safety outlet.
 - a. Do not substitute the power cord with one that is not the provided approved type. Never use an adapter plug to connect to a 2-wire outlet as this will defeat the continuity of the grounding wire.
 - b. The equipment requires the use of the ground wire as a part of the safety certification, modification or misuse can provide a shock hazard that can result in serious injury or death.
 - c. Contact a qualified electrician or the manufacturer if there are questions about the installation prior to connecting the equipment.
 - d. Protective earthing is provided by Listed AC adapter. Building installation shall provide appropriate short-circuit backup protection.
 - e. Protective bonding must be installed in accordance with local national wiring rules and regulations.

Appendix C: Warranty

Limited Warranty

UBIQUITI NETWORKS, Inc (“UBIQUITI NETWORKS”) warrants that the product(s) furnished hereunder (the “Product(s)”) shall be free from defects in material and workmanship for a period of one (1) year from the date of shipment by UBIQUITI NETWORKS under normal use and operation. UBIQUITI NETWORKS’ sole and exclusive obligation and liability under the foregoing warranty shall be for UBIQUITI NETWORKS, at its discretion, to repair or replace any Product that fails to conform to the above warranty during the above warranty period. The expense of removal and reinstallation of any Product is not included in this warranty. The warranty period of any repaired or replaced Product shall not extend beyond its original term.

Warranty Conditions

The above warranty does not apply if the Product:

- (I) has been modified and/or altered, or an addition made thereto, except by Ubiquiti Networks, or Ubiquiti Networks’ authorized representatives, or as approved by Ubiquiti Networks in writing;
- (II) has been painted, rebranded or physically modified in any way;
- (III) has been damaged due to errors or defects in cabling;
- (IV) has been subjected to misuse, abuse, negligence, abnormal physical, electromagnetic or electrical stress, including lightning strikes, or accident;
- (V) has been damaged or impaired as a result of using third party firmware; or
- (VI) has no original Ubiquiti MAC label, or is missing any other original Ubiquiti label(s).
- (VII) has not been received by Ubiquiti within 30 days of issuance of the RMA.

In addition, the above warranty shall apply only if: the product has been properly installed and used at all times in accordance, and in all material respects, with the applicable Product documentation; all Ethernet cabling runs use CAT5 (or above), and for outdoor installations, shielded Ethernet cabling is used, and for indoor installations, indoor cabling requirements are followed.

Returns

No Products will be accepted for replacement or repair without obtaining a Return Materials Authorization (RMA) number from UBIQUITI NETWORKS during the warranty period, and the Products being received at UBIQUITI NETWORKS’ facility freight prepaid in accordance with the RMA process of UBIQUITI NETWORKS. Products returned without an RMA number will not be processed and will be returned freight collect or subject to disposal. Information on the RMA process and obtaining an RMA number can be found at: www.ubnt.com/support/warranty

Disclaimer

EXCEPT FOR ANY EXPRESS WARRANTIES PROVIDED HEREIN, UBIQUITI NETWORKS, ITS AFFILIATES, AND ITS AND THEIR THIRD PARTY DATA, SERVICE, SOFTWARE AND HARDWARE PROVIDERS HEREBY DISCLAIM AND MAKE NO OTHER REPRESENTATION OR WARRANTY OF ANY KIND, EXPRESS, IMPLIED OR STATUTORY, INCLUDING, BUT NOT LIMITED TO, REPRESENTATIONS, GUARANTEES, OR WARRANTIES OF MERCHANTABILITY, ACCURACY, QUALITY OF SERVICE OR RESULTS, AVAILABILITY, SATISFACTORY QUALITY, LACK OF VIRUSES, QUIET ENJOYMENT, FITNESS FOR A PARTICULAR PURPOSE AND NON-INFRINGEMENT AND ANY WARRANTIES ARISING FROM ANY COURSE OF DEALING, USAGE OR TRADE PRACTICE IN CONNECTION WITH SUCH PRODUCTS AND SERVICES. BUYER ACKNOWLEDGES THAT NEITHER UBIQUITI NETWORKS NOR ITS THIRD PARTY PROVIDERS CONTROL BUYER’S EQUIPMENT OR THE TRANSFER OF DATA OVER COMMUNICATIONS FACILITIES, INCLUDING THE INTERNET, AND THAT THE PRODUCTS AND SERVICES MAY BE SUBJECT TO LIMITATIONS, INTERRUPTIONS, DELAYS, CANCELLATIONS AND OTHER PROBLEMS INHERENT IN THE USE OF COMMUNICATIONS FACILITIES. UBIQUITI NETWORKS, ITS AFFILIATES AND ITS AND THEIR THIRD PARTY PROVIDERS ARE NOT RESPONSIBLE FOR ANY INTERRUPTIONS, DELAYS, CANCELLATIONS, DELIVERY FAILURES, DATA LOSS, CONTENT CORRUPTION, PACKET LOSS, OR OTHER DAMAGE RESULTING FROM ANY OF THE FOREGOING. In addition, UBIQUITI NETWORKS does not warrant that the operation of the Products will be error-free or that operation will be uninterrupted. In no event shall UBIQUITI NETWORKS be responsible for damages or claims of any nature or description relating to system performance, including coverage, buyer’s selection of products (including the Products) for buyer’s application and/or failure of products (including the Products) to meet government or regulatory requirements.



WARNING: Failure to properly ground your airFiber units will void your warranty. (Please follow the instructions on “**Grounding**” on page **10** for installation of the ground wires.)

Limitation of Liability

EXCEPT TO THE EXTENT PROHIBITED BY LOCAL LAW, IN NO EVENT WILL UBIQUITI OR ITS SUBSIDIARIES, AFFILIATES OR SUPPLIERS BE LIABLE FOR DIRECT, SPECIAL, INCIDENTAL, CONSEQUENTIAL OR OTHER DAMAGES (INCLUDING LOST PROFIT, LOST DATA, OR DOWNTIME COSTS), ARISING OUT OF THE USE, INABILITY TO USE, OR THE RESULTS OF USE OF THE PRODUCT, WHETHER BASED IN WARRANTY, CONTRACT, TORT OR OTHER LEGAL THEORY, AND WHETHER OR NOT ADVISED OF THE POSSIBILITY OF SUCH DAMAGES.

Note

Some countries, states and provinces do not allow exclusions of implied warranties or conditions, so the above exclusion may not apply to you. You may have other rights that vary from country to country, state to state, or province to province. Some countries, states and provinces do not allow the exclusion or limitation of liability for incidental or consequential damages, so the above limitation may not apply to you. EXCEPT TO THE EXTENT ALLOWED BY LOCAL LAW, THESE WARRANTY TERMS DO NOT EXCLUDE, RESTRICT OR MODIFY, AND ARE IN ADDITION TO, THE MANDATORY STATUTORY RIGHTS APPLICABLE TO THE LICENSE OF ANY SOFTWARE (EMBEDDED IN THE PRODUCT) TO YOU. The United Nations Convention on Contracts for the International Sale of Goods shall not apply to any transactions regarding the sale of the Products.

Appendix D: Compliance Information

Installer Compliance Responsibility

Devices must be professionally installed and it is the professional installer's responsibility to make sure the device is operated within local country regulatory requirements.

FCC

Changes or modifications not expressly approved by the party responsible for compliance could void the user's authority to operate the equipment.

This device complies with Part 15 of the FCC Rules. Operation is subject to the following two conditions:

1. This device may not cause harmful interference, and
2. This device must accept any interference received, including interference that may cause undesired operation.

This equipment has been tested and found to comply with the limits for a Class A digital device, pursuant to part 15 of the FCC Rules. These limits are designed to provide reasonable protection against harmful interference when the equipment is operated in a commercial environment. This equipment generates, uses, and can radiate radio frequency energy and, if not installed and used in accordance with the instruction manual, may cause harmful interference to radio communications. Operations of this equipment in a residential area is likely to cause harmful interference in which case the user will be required to correct the interference at his own expense.

ISED Canada

CAN ICES-3(A)/NMB-3(A)

This device complies with ISED Canada licence-exempt RSS standard(s). Operation is subject to the following two conditions:

1. This device may not cause interference, and
2. This device must accept any interference, including interference that may cause undesired operation of the device.

CAN ICES-3(A)/NMB-3(A)

Le présent appareil est conforme aux CNR d'ISDE Canada applicables aux appareils radio exempts de licence. L'exploitation est autorisée aux deux conditions suivantes :

1. l'appareil ne doit pas produire de brouillage;
2. l'appareil doit accepter tout brouillage radioélectrique subi, même si le brouillage est susceptible d'en compromettre le fonctionnement.

RF Exposure Warning

The antennas used for this transmitter must be installed to provide a separation distance of at least 107 cm from all persons and must not be located or operating in conjunction with any other antenna or transmitter.

Les antennes utilisées pour ce transmetteur doivent être installé en considérant une distance de séparation de toute personnes d'au moins 107 cm et ne doivent pas être localisé ou utilisé en conflit avec tout autre antenne ou transmetteur.

CE Marking

CE marking on this product represents the product is in compliance with all directives that are applicable to it. This equipment is intended to be accessed only by service personnel and/or trained professionals.



RoHS/WEEE Compliance Statement



English

European Directive 2012/19/EU requires that the equipment bearing this symbol on the product and/or its packaging must not be disposed of with unsorted municipal waste. The symbol indicates that this product should be disposed of separately from regular household waste streams. It is your responsibility to dispose of this and other electric and electronic equipment via designated collection facilities appointed by the government or local authorities. Correct disposal and recycling will help prevent potential negative consequences to the environment and human health. For more detailed information about the disposal of your old equipment, please contact your local authorities, waste disposal service, or the shop where you purchased the product.

Deutsch

Die Europäische Richtlinie 2012/19/EU verlangt, dass technische Ausrüstung, die direkt am Gerät und/oder an der Verpackung mit diesem Symbol versehen ist, nicht zusammen mit unsortiertem Gemeindeabfall entsorgt werden darf. Das Symbol weist darauf hin, dass das Produkt von regulärem Haushaltsmüll getrennt entsorgt werden sollte. Es liegt in Ihrer Verantwortung, dieses Gerät und andere elektrische und elektronische Geräte über die dafür zuständigen und von der Regierung oder örtlichen Behörden dazu bestimmten Sammelstellen zu entsorgen. Ordnungsgemäßes Entsorgen und Recyceln trägt dazu bei, potentielle negative Folgen für Umwelt und die menschliche Gesundheit zu vermeiden. Wenn Sie weitere Informationen zur Entsorgung Ihrer Altgeräte benötigen, wenden Sie sich bitte an die örtlichen Behörden oder städtischen Entsorgungsdienste oder an den Händler, bei dem Sie das Produkt erworben haben.

Español

La Directiva 2012/19/UE de la UE exige que los equipos que lleven este símbolo en el propio aparato y/o en su embalaje no deben eliminarse junto con otros residuos urbanos no seleccionados. El símbolo indica que el producto en cuestión debe separarse de los residuos domésticos convencionales con vistas a su eliminación. Es responsabilidad suya desechar este y cualesquiera otros aparatos eléctricos y electrónicos a través de los puntos de recogida que ponen a su disposición el gobierno y las autoridades locales. Al desechar y reciclar correctamente estos aparatos estará contribuyendo a evitar posibles consecuencias negativas para el medio ambiente y la salud de las personas. Si desea obtener información más detallada sobre la eliminación segura de su aparato usado, consulte a las autoridades locales, al servicio de recogida y eliminación de residuos de su zona o pregunte en la tienda donde adquirió el producto.

Français

La directive européenne 2012/19/UE exige que l'équipement sur lequel est apposé ce symbole sur le produit et/ou son emballage ne soit pas jeté avec les autres ordures ménagères. Ce symbole indique que le produit doit être éliminé dans un circuit distinct de celui pour les déchets des ménages. Il est de votre responsabilité de jeter ce matériel ainsi que tout autre matériel électrique ou électronique par les moyens de collecte indiqués par le gouvernement et les pouvoirs publics des collectivités territoriales. L'élimination et le recyclage en bonne et due forme ont pour but de lutter contre l'impact néfaste potentiel de ce type de produits sur l'environnement et la santé publique. Pour plus d'informations sur le mode d'élimination de votre ancien équipement, veuillez prendre contact avec les pouvoirs publics locaux, le service de traitement des déchets, ou l'endroit où vous avez acheté le produit.

Italiano

La direttiva europea 2012/19/UE richiede che le apparecchiature contrassegnate con questo simbolo sul prodotto e/o sull'imballaggio non siano smaltite insieme ai rifiuti urbani non differenziati. Il simbolo indica che questo prodotto non deve essere smaltito insieme ai normali rifiuti domestici. È responsabilità del proprietario smaltire sia questi prodotti sia le altre apparecchiature elettriche ed elettroniche mediante le specifiche strutture di raccolta indicate dal governo o dagli enti pubblici locali. Il corretto smaltimento ed il riciclaggio aiuteranno a prevenire conseguenze potenzialmente negative per l'ambiente e per la salute dell'essere umano. Per ricevere informazioni più dettagliate circa lo smaltimento delle vecchie apparecchiature in Vostro possesso, Vi invitiamo a contattare gli enti pubblici di competenza, il servizio di smaltimento rifiuti o il negozio nel quale avete acquistato il prodotto.

Appendix E: Declaration of Conformity

български [Bulgarian]	С настоящото UBIQUITI NETWORKS декларира, че този тип радиосъоръжение AF-24/AF-24HD е в съответствие с Директива 2014/53/ЕС. Цялостният текст на ЕС декларацията за съответствие може да се намери на следния интернет адрес: www.ubnt.com/compliance	Lietuvių kalba [Lithuanian]	Aš, UBIQUITI NETWORKS, patvirtinu, kad radijo įrenginių tipas AF-24/AF-24HD atitinka Direktyvą 2014/53/ES. Visas ES atitikties deklaracijos tekstas prieinamas šiuo interneto adresu: www.ubnt.com/compliance
Hrvatski [Croatian]	UBIQUITI NETWORKS ovime izjavljuje da je radijska oprema tipa AF-24/AF-24HD u skladu s Direktivom 2014/53/EU. Cjeloviti tekst EU izjave o sukladnosti dostupan je na sljedećoj internetskoj adresi: www.ubnt.com/compliance	Malti [Maltese]	B'dan, UBIQUITI NETWORKS, niddikjara li dan it-tip ta' taghmir tar-radju AF-24/AF-24HD huwa konformi mad-Direttiva 2014/53/UE. Id-dikjarazzjoni tal-konformità tista' tigi kkonsultata minn www.ubnt.com/compliance
Čeština [Czech]	Tímto UBIQUITI NETWORKS prohlašuje, že typ rádiového zařízení AF-24/AF-24HD je v souladu se směrnicí 2014/53/EU. Úplné znění EU prohlášení o shodě je k dispozici na této internetové adrese: www.ubnt.com/compliance	Norsk [Norwegian]	UBIQUITI NETWORKS erklærer herved at utstyret AF-24/AF-24HD er i samsvar med de grunnleggende krav og øvrige relevante krav i direktiv 2014/53/EU. Den fulle teksten til EU-samsvarserklæringen er tilgjengelig på følgende internetadresse: www.ubnt.com/compliance
Dansk [Danish]	Hermed erklærer UBIQUITI NETWORKS, at radioudstyrstypen AF-24/AF-24HD er i overensstemmelse med direktiv 2014/53/EU. EU-overensstemmelseserklæringens fulde tekst kan findes på følgende internetadresse: www.ubnt.com/compliance	Polski [Polish]	UBIQUITI NETWORKS niniejszym oświadcza, że typ urządzenia radiowego AF-24/AF-24HD jest zgodny z dyrektywą 2014/53/UE. Pełny tekst deklaracji zgodności UE jest dostępny pod następującym adresem internetowym: www.ubnt.com/compliance
Nederlands [Dutch]	Hierbij verklaar ik, UBIQUITI NETWORKS, dat het type radioapparatuur AF-24/AF-24HD conform is met Richtlijn 2014/53/EU. De volledige tekst van de EU-conformiteitsverklaring kan worden geraadpleegd op het volgende internetadres: www.ubnt.com/compliance	Português [Portuguese]	O(a) abaixo assinado(a) UBIQUITI NETWORKS declara que o presente tipo de equipamento de rádio AF-24/AF-24HD está em conformidade com a Diretiva 2014/53/UE. O texto integral da declaração de conformidade está disponível no seguinte endereço de Internet: www.ubnt.com/compliance
English	Hereby, UBIQUITI NETWORKS declares that the radio equipment type AF-24/AF-24HD is in compliance with Directive 2014/53/EU. The full text of the EU declaration of conformity is available at the following internet address: www.ubnt.com/compliance	Română [Romanian]	Prin prezenta, UBIQUITI NETWORKS declară că tipul de echipamente radio AF-24/AF-24HD este în conformitate cu Directiva 2014/53/UE. Textul integral al declarației UE de conformitate este disponibil în următoarea adresă internet: www.ubnt.com/compliance
Eesti keel [Estonian]	Käesolevaga deklareerib UBIQUITI NETWORKS, et käesolev raadioseadme tüüp AF-24/AF-24HD vastab direktiivi 2014/53/EU nõuetele. ELi vastavusdeklaratsiooni täielik tekst on kättesaadav järgmisel internetiaadressil: www.ubnt.com/compliance	Slovenčina [Slovak]	UBIQUITI NETWORKS týmto vyhlasuje, že rádiové zariadenie typu AF-24/AF-24HD je v súlade so smernicou 2014/53/EU. Úplné EÚ vyhlásenie o zhode je k dispozícii na tejto internetovej adrese: www.ubnt.com/compliance
Suomi [Finnish]	UBIQUITI NETWORKS vakuuttaa, että radiolaitetyyppi AF-24/AF-24HD on direktiivin 2014/53/EU mukainen. EU-vaatimustenmukaisuusvakuutuksen täysimittainen teksti on saatavilla seuraavassa internetosoitteessa: www.ubnt.com/compliance	Slovenščina [Slovenian]	UBIQUITI NETWORKS potrjuje, da je tip radijske opreme AF-24/AF-24HD skladen z Direktivo 2014/53/EU. Celotno besedilo izjave EU o skladnosti je na voljo na naslednjem spletnem naslovu: www.ubnt.com/compliance
Français [French]	Le soussigné, UBIQUITI NETWORKS, déclare que l'équipement radioélectrique du type AF-24/AF-24HD est conforme à la directive 2014/53/UE. Le texte complet de la déclaration UE de conformité est disponible à l'adresse internet suivante: www.ubnt.com/compliance	Español [Spanish]	Por la presente, UBIQUITI NETWORKS declara que el tipo de equipo radioeléctrico AF-24/AF-24HD es conforme con la Directiva 2014/53/UE. El texto completo de la declaración UE de conformidad está disponible en la dirección Internet siguiente: www.ubnt.com/compliance
Deutsch [German]	Hiermit erklärt UBIQUITI NETWORKS, dass der Funkanlagentyp AF-24/AF-24HD der Richtlinie 2014/53/EU entspricht. Der vollständige Text der EU-Konformitätserklärung ist unter der folgenden Internetadresse verfügbar: www.ubnt.com/compliance	Svenska [Swedish]	Härmed försäkras UBIQUITI NETWORKS att denna typ av radioutrustning AF-24/AF-24HD överensstämmer med direktiv 2014/53/EU. Den fullständiga texten till EU-försäkran om överensstämmelse finns på följande webbadress: www.ubnt.com/compliance
Ελληνική [Greek]	Με την παρούσα ο/η UBIQUITI NETWORKS, δηλώνει ότι ο ραδιοεξοπλισμός AF-24/AF-24HD πληροί την οδηγία 2014/53/ΕΕ. Το πλήρες κείμενο της δήλωσης συμμόρφωσης ΕΕ διατίθεται στην ακόλουθη ιστοσελίδα στο διαδίκτυο: www.ubnt.com/compliance		
Magyar [Hungarian]	UBIQUITI NETWORKS igazolja, hogy a AF-24/AF-24HD típusú rádióberendezés megfelel a 2014/53/EU irányelvnek. Az EU-megfelelőségi nyilatkozat teljes szövege elérhető a következő internetes címen: www.ubnt.com/compliance		
Íslenska [Icelandic]	Hér með lýsir UBIQUITI NETWORKS yfir því að AF-24/AF-24HD er í samræmi við grunnkröfur og aðrar kröfur, sem gerðar eru í tilskipun 2014/53/EU. Fullur texti ESB samræmisýfirlýsing er að finna á eftirfarandi netfangi: www.ubnt.com/compliance		
Italiano [Italian]	Il fabbricante, UBIQUITI NETWORKS, dichiara che il tipo di apparecchiatura radio AF-24/AF-24HD è conforme alla direttiva 2014/53/UE. Il testo completo della dichiarazione di conformità UE è disponibile al seguente indirizzo Internet: www.ubnt.com/compliance		
Latviešu valoda [Latvian]	Ar šo UBIQUITI NETWORKS deklarē, ka radioiekārta AF-24/AF-24HD atbilst Direktīvai 2014/53/ES. Pilns ES atbilstības deklarācijas teksts ir pieejams šādā interneta vietnē: www.ubnt.com/compliance		

Appendix F: Contact Information

Ubiquiti Networks Support

Ubiquiti Support Engineers are located around the world and are dedicated to helping customers resolve software, hardware compatibility, or field issues as quickly as possible. We strive to respond to support inquiries within a 24-hour period.

Ubiquiti Networks, Inc.
685 Third Avenue, 27th Floor
New York, NY 10017
USA

www.ubnt.com

Online Resources

Support: ubnt.link/airFiber-Support

Community: community.ubnt.com/airfiber

Downloads: www.ubnt.com/download/airfiber

© 2012-2018 Ubiquiti Networks, Inc. All rights reserved. Ubiquiti, Ubiquiti Networks, the Ubiquiti U logo, the Ubiquiti beam logo, airFiber, airOS, airView, EdgeRouter, TOUGHCable, and UNMS are trademarks or registered trademarks of Ubiquiti Networks, Inc. in the United States and in other countries. Google Maps is a trademark of Google LLC. All other trademarks are the property of their respective owners.



www.ubuntu.com