

## *airGrid*® **M5 HP**

5 GHz High-Performance  
Integrated InnerFeed®  
Antenna

Model: AG-HP-5G27

QUICK START GUIDE

## Introduction

Thank you for purchasing the Ubiquiti Networks® airGrid®M5 HP. This Quick Start Guide is designed to guide you through installation and includes warranty terms.

## Package Contents

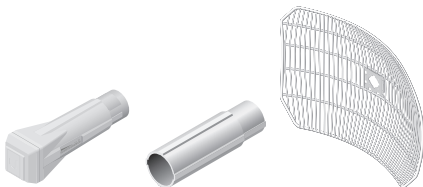

Antenna Feed

Feed Extender\*

Grid Reflector\*



Rear Housing



L-Bracket\*



Pole Clamp\*



U-Bolt\*



Flange Nuts\*  
(M8, Qty. 2)



PoE Adapter with  
Mount Bracket  
(24V, 0.5A)



Power Cord



Quick Start  
Guide

\* The Feed Extender, Grid Reflector and mounting hardware are packaged separately. Products may be different from pictures and are subject to change without notice.

TERMS OF USE: Ubiquiti radio devices must be professionally installed. Shielded Ethernet cable and earth grounding must be used as conditions of product warranty. TOUGH Cable™ is designed for outdoor installations. It is the customer's responsibility to follow local country regulations, including operation within legal frequency channels, output power, and Dynamic Frequency Selection (DFS) requirements.

## Installation Requirements

- 13 mm or ½" wrench
- Shielded Category 5 (or above) cabling should be used for all wired Ethernet connections and should be grounded through the AC ground of the PoE.

We recommend that you protect your networks from harmful outdoor environments and destructive ESD events with industrial-grade, shielded Ethernet cable from Ubiquiti Networks. For more details, visit:

**[www.ubnt.com/toughcable](http://www.ubnt.com/toughcable)**

## Application Examples

The airGrid mounted outdoors with the *Grid Reflector* installed provides directional outdoor coverage (gain reflector-dependent).

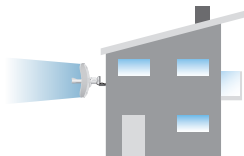



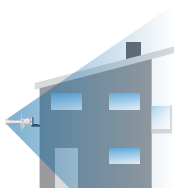

The airGrid mounted outdoors without the *Grid Reflector* installed provides outdoor-to-indoor coverage using the 3 dBi *Antenna Feed* only.





## LEDs



**Signal** In airOS, you can modify the wireless signal strength threshold values for each LED on the *Advanced* tab under *Signal LED Thresholds*. The default values are shown below:

-  LED will light green when the wireless signal strength is above -65 dBm.
-  LED will light green when the wireless signal strength is above -73 dBm.
-  LED will light amber when the wireless signal strength is above -80 dBm.
-  LED will light red when the wireless signal strength is above -94 dBm.

 **Ethernet** The Ethernet LED will light steady green when an active Ethernet connection is made and flash when there is activity.

 **Power** The Power LED will light green when the device is connected to a power source.

## Hardware Installation

Assemble the airGrid according to your chosen polarization.

1. Attach the *L-Bracket* to the *Grid Reflector* by sliding the tabs into the slots.

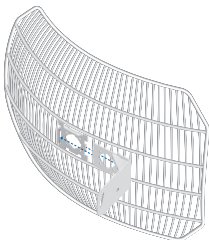

*Vertical Polarization*

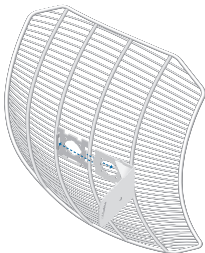

*Horizontal Polarization*

**!** **IMPORTANT:** The polarization of the airGrids must match on both ends of the wireless link (horizontal to horizontal, vertical to vertical).

2. On the front of the airGrid, ensure the polarization indicator, *V* or *H*, properly matches your desired polarization.

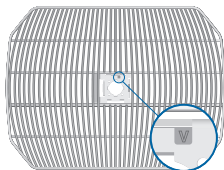

*Vertical Polarization*

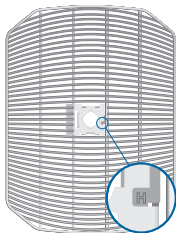

*Horizontal Polarization*

3. Attach the *Rear Housing*:

- a. Ensure the four alignment holes on the *Grid Reflector* and *L-Bracket* are lined up.
- b. Orient the *Rear Housing* with the locking tab of the cable feed door facing up.
- c. Insert the alignments pins of the *Rear Housing* into the alignment holes, and push until the *Rear Housing* locks into place with a click.

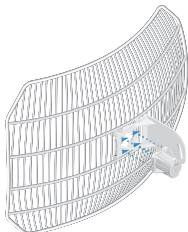

*Vertical Polarization*

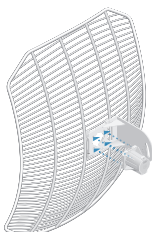

*Horizontal Polarization*

- d. Insert the *Feed Extender* into the *Rear Housing* with the *Release Button* facing down. Push until it locks into place with a click.

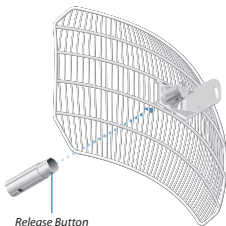

*Release Button*



640-00075-03

4. Lift the locking tab of the cable feed door and detach the door from the *Rear Housing*.

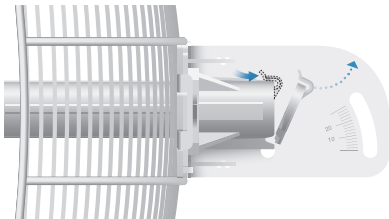

5. Route an Ethernet cable through the *Rear Housing* and *Feed Extender*. Connect the cable to the Ethernet port on the back of the *Antenna Feed*.

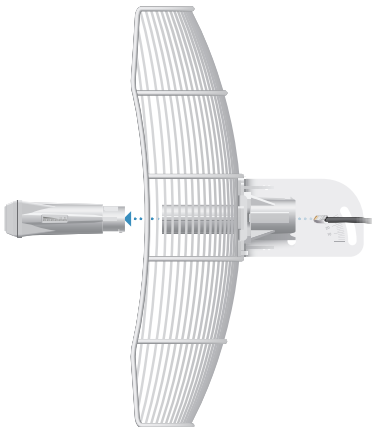

6. Attach the *Antenna Feed*:
- Rotate the *Antenna Feed* to match the signal polarization.
  - Insert the *Antenna Feed* into the *Feed Extender*, and push until it locks into place with a click.

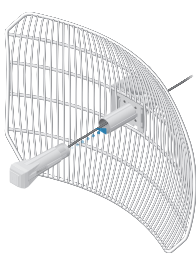

*Vertical Polarization*

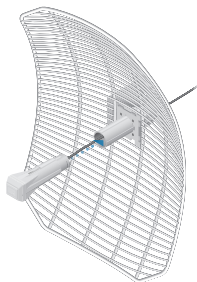

*Horizontal Polarization*

7. Lightly pull the *Antenna Feed* to ensure that the *Release Button* is fully engaged and locked into place.

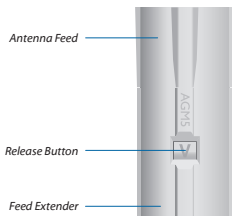

*Bottom View*



**Note:** If you need to remove the *Antenna Feed*, you must depress the *Release Button* first.



8. The *Release Button* indicates the *Antenna Feed* polarization. Confirm that the polarization indicator, *V* or *H*, on the *Antenna Feed* matches the indicator on the *Grid Reflector*.

**!** **IMPORTANT:** The polarization indicators must match.

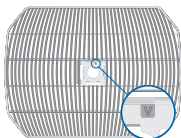

*Vertical Polarization*

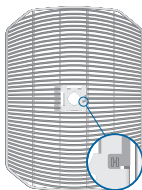

*Horizontal Polarization*

9. Re-attach the cable feed door to the *Rear Housing*. Ensure the locking tab securely latches to the *Rear Housing*.

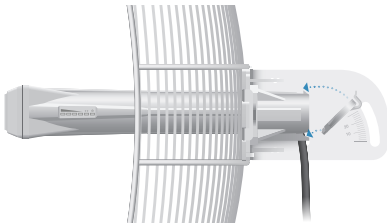

10. Slide the *Pole Clamp* onto the *L-Bracket*.

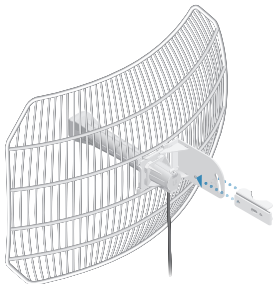

11. Insert the *U-Bolt* into the *Pole Clamp* and *L-Bracket*. Secure each end of the *U-Bolt* with a *Flange Nut*.

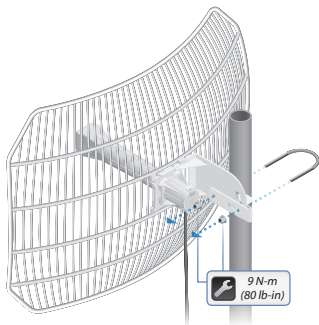

**Note:** The mounting assembly can accommodate a  $\varnothing$  32 - 56 mm (1.25 - 2.2") pole.

## Connecting to Power over Ethernet

1. Connect the Ethernet cable from the airGrid to the **POE** port of the *PoE Adapter*.
2. Connect an Ethernet cable from your LAN to the **LAN** port of the *PoE Adapter*.
3. Connect the *Power Cord* to the adapter, and then plug the *Power Cord* into a power outlet.



## Mounting the PoE Adapter (Optional)

1. Remove the *PoE Mounting Bracket* from the adapter, place the bracket at the desired location, and mark the two holes.
2. Pre-drill the holes if necessary, and secure the bracket using two fasteners (not included).
3. Align the adapter's slots with the tabs of the *PoE Mounting Bracket*, and then slide the adapter down.



## airOS® Configuration

Verify connectivity in the airOS Configuration Interface and select the airGrid antenna size.

1. Make sure that your host system is connected via Ethernet to the airGrid.
2. Configure the Ethernet adapter on your host system with a static IP address on the 192.168.1.x subnet.
3. Launch your web browser and type **https://192.168.1.20** in the address field. Press **enter** (PC) or **return** (Mac).

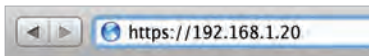

4. The login screen will appear. Enter **ubnt** in the *Username* and *Password* fields. Select your *Country* and *Language*. You must agree to the *Terms of Use* to use the product. Click **Login**.



**Note:** U.S. product versions are locked to the U.S. Country Code to ensure compliance with FCC regulations.



5. Select the airGrid antenna size:
  - a. Click the **Wireless** tab.
  - b. From the *Antenna* drop-down list, select the appropriate option.
  - c. Click **Change** to save.
  - d. Click **OK** to confirm.

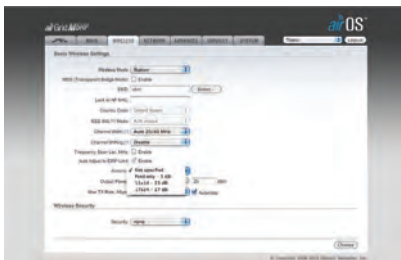

Customize additional settings as needed to complete the installation.

For additional details on the airOS Configuration Interface, refer to the User Guide available at:  
**[documentation.ubnt.com/airmax](http://documentation.ubnt.com/airmax)**



## Specifications

AG-HP-5G27	
Dimensions	620 x 460 x 360 mm (24.41 x 18.11 x 14.17")
Weight	2585 g (91.18 oz)
Networking Interface	(1) 10/100 Ethernet Port
Enclosure	Outdoor UV Stabilized Plastic
Frequency	Worldwide: 5170 - 5875 MHz USA: 5725 - 5850 MHz
Gain	27 dBi
Output Power	25 dBm
Max. Power Consumption	3W
Power Supply	24V, 0.5A PoE Adapter (Included)
Power Method	Passive Power over Ethernet (Pairs 4, 5+; 7, 8 Return)
Max. VSWR	1.5:1
Wind Survivability	200 km/h (125 mph)
Wind Loading	34.7 N @ 200 km/h (7.8 lbf @ 125 mph)
ETSI Specification	EN 302 326 DN2
Shock and Vibration	ETSI300-019-1.4
Certifications	FCC, IC, CE
Operating Temperature	-30 to 75° C (-22 to 167° F)
Operating Humidity	5 to 95% Noncondensing

## Safety Notices

1. Read, follow, and keep these instructions.
2. Heed all warnings.
3. Only use attachments/accessories specified by the manufacturer.



**WARNING:** Do not use this product in location that can be submerged by water.



**WARNING:** Avoid using this product during an electrical storm. There may be a remote risk of electric shock from lightning.

## Electrical Safety Information

1. Compliance is required with respect to voltage, frequency, and current requirements indicated on the manufacturer's label. Connection to a different power source than those specified may result in improper operation, damage to the equipment or pose a fire hazard if the limitations are not followed.
2. There are no operator serviceable parts inside this equipment. Service should be provided only by a qualified service technician.
3. This equipment is provided with a detachable power cord which has an integral safety ground wire intended for connection to a grounded safety outlet.
  - a. Do not substitute the power cord with one that is not the provided approved type. Never use an adapter plug to connect to a 2-wire outlet as this will defeat the continuity of the grounding wire.
  - b. The equipment requires the use of the ground wire as a part of the safety certification, modification or misuse can provide a shock hazard that can result in serious injury or death.
  - c. Contact a qualified electrician or the manufacturer if there are questions about the installation prior to connecting the equipment.
  - d. Protective earthing is provided by Listed AC adapter. Building installation shall provide appropriate short-circuit backup protection.
  - e. Protective bonding must be installed in accordance with local national wiring rules and regulations.



## Limited Warranty

UBIQUITI NETWORKS, Inc (“UBIQUITI NETWORKS”) warrants that the product(s) furnished hereunder (the “Product(s)”) shall be free from defects in material and workmanship for a period of one (1) year from the date of shipment by UBIQUITI NETWORKS under normal use and operation. UBIQUITI NETWORKS’ sole and exclusive obligation and liability under the foregoing warranty shall be for UBIQUITI NETWORKS, at its discretion, to repair or replace any Product that fails to conform to the above warranty during the above warranty period. The expense of removal and reinstallation of any Product is not included in this warranty. The warranty period of any repaired or replaced Product shall not extend beyond its original term.

## Warranty Conditions

The above warranty does not apply if the Product:

- (I) has been modified and/or altered, or an addition made thereto, except by Ubiquiti Networks, or Ubiquiti Networks’ authorized representatives, or as approved by Ubiquiti Networks in writing;
- (II) has been painted, rebranded or physically modified in any way;
- (III) has been damaged due to errors or defects in cabling;
- (IV) has been subjected to misuse, abuse, negligence, abnormal physical, electromagnetic or electrical stress, including lightning strikes, or accident;
- (V) has been damaged or impaired as a result of using third party firmware;
- (VI) has no original Ubiquiti MAC label, or is missing any other original Ubiquiti label(s); or
- (VII) has not been received by Ubiquiti within 30 days of issuance of the RMA.

In addition, the above warranty shall apply only if: the product has been properly installed and used at all times in accordance, and in all material respects, with the applicable Product documentation; all Ethernet cabling runs use CAT5 (or above), and for outdoor installations, shielded Ethernet cabling is used, and for indoor installations, indoor cabling requirements are followed.

## Returns

No Products will be accepted for replacement or repair without obtaining a Return Materials Authorization (RMA) number from UBIQUITI NETWORKS during the warranty period, and the Products being received at UBIQUITI NETWORKS’ facility freight prepaid in accordance with the RMA process of UBIQUITI NETWORKS. Products returned without an RMA number will not be processed and will be returned freight collect or subject to disposal. Information on the RMA process and obtaining an RMA number can be found at: [www.ubnt.com/support/warranty](http://www.ubnt.com/support/warranty).

## Disclaimer

EXCEPT FOR ANY EXPRESS WARRANTIES PROVIDED HEREIN, UBIQUITI NETWORKS, ITS AFFILIATES, AND ITS AND THEIR THIRD PARTY DATA, SERVICE, SOFTWARE AND HARDWARE PROVIDERS HEREBY DISCLAIM AND MAKE NO OTHER REPRESENTATION OR WARRANTY OF ANY KIND, EXPRESS, IMPLIED OR STATUTORY, INCLUDING, BUT NOT LIMITED TO, REPRESENTATIONS, GUARANTEES, OR WARRANTIES OF MERCHANTABILITY, ACCURACY, QUALITY OF SERVICE OR RESULTS, AVAILABILITY, SATISFACTORY QUALITY, LACK OF VIRUSES, QUIET ENJOYMENT, FITNESS FOR A PARTICULAR PURPOSE AND NON-INFRINGEMENT AND ANY WARRANTIES ARISING FROM ANY COURSE OF DEALING, USAGE OR TRADE PRACTICE IN CONNECTION WITH SUCH PRODUCTS AND SERVICES. BUYER ACKNOWLEDGES THAT NEITHER UBIQUITI NETWORKS NOR ITS THIRD PARTY PROVIDERS CONTROL BUYER'S EQUIPMENT OR THE TRANSFER OF DATA OVER COMMUNICATIONS FACILITIES, INCLUDING THE INTERNET, AND THAT THE PRODUCTS AND SERVICES MAY BE SUBJECT TO LIMITATIONS, INTERRUPTIONS, DELAYS, CANCELLATIONS AND OTHER PROBLEMS INHERENT IN THE USE OF COMMUNICATIONS FACILITIES. UBIQUITI NETWORKS, ITS AFFILIATES AND ITS AND THEIR THIRD PARTY PROVIDERS ARE NOT RESPONSIBLE FOR ANY INTERRUPTIONS, DELAYS, CANCELLATIONS, DELIVERY FAILURES, DATA LOSS, CONTENT CORRUPTION, PACKET LOSS, OR OTHER DAMAGE RESULTING FROM ANY OF THE FOREGOING. In addition, UBIQUITI NETWORKS does not warrant that the operation of the Products will be error-free or that operation will be uninterrupted. In no event shall UBIQUITI NETWORKS be responsible for damages or claims of any nature or description relating to system performance, including coverage, buyer's selection of products (including the Products) for buyer's application and/or failure of products (including the Products) to meet government or regulatory requirements.

## Limitation of Liability

EXCEPT TO THE EXTENT PROHIBITED BY LOCAL LAW, IN NO EVENT WILL UBIQUITI OR ITS SUBSIDIARIES, AFFILIATES OR SUPPLIERS BE LIABLE FOR DIRECT, SPECIAL, INCIDENTAL, CONSEQUENTIAL OR OTHER DAMAGES (INCLUDING LOST PROFIT, LOST DATA, OR DOWNTIME COSTS), ARISING OUT OF THE USE, INABILITY TO USE, OR THE RESULTS OF USE OF THE PRODUCT, WHETHER BASED IN WARRANTY, CONTRACT, TORT OR OTHER LEGAL THEORY, AND WHETHER OR NOT ADVISED OF THE POSSIBILITY OF SUCH DAMAGES.

## Note

Some countries, states and provinces do not allow exclusions of implied warranties or conditions, so the above exclusion may not apply to you. You may have other rights that vary from country to country, state to state, or province to province. Some countries, states and provinces do not allow the exclusion or limitation of liability for incidental or consequential damages, so the above limitation may not apply to you. EXCEPT TO THE EXTENT ALLOWED BY LOCAL LAW, THESE WARRANTY TERMS DO NOT EXCLUDE, RESTRICT OR MODIFY, AND ARE IN ADDITION TO, THE MANDATORY STATUTORY RIGHTS APPLICABLE TO THE LICENSE OF ANY SOFTWARE (EMBEDDED IN THE PRODUCT) TO YOU. The United Nations Convention on Contracts for the International Sale of Goods shall not apply to any transactions regarding the sale of the Products.

## Compliance

### FCC

Changes or modifications not expressly approved by the party responsible for compliance could void the user's authority to operate the equipment.

This device complies with Part 15 of the FCC Rules. Operation is subject to the following two conditions:

1. This device may not cause harmful interference, and
2. This device must accept any interference received, including interference that may cause undesired operation.

NOTE: This equipment has been tested and found to comply with the limits for a Class A digital device, pursuant to part 15 of the FCC Rules. These limits are designed to provide reasonable protection against harmful interference when the equipment is operated in a commercial environment. This equipment generates, uses, and can radiate radio frequency energy and, if not installed and used in accordance with the instruction manual, may cause harmful interference to radio communications. Operations of this equipment in a residential area is likely to cause harmful interference in which case the user will be required to correct the interference at his own expense.

## Industry Canada

This Class A digital apparatus complies with Canadian ICES-003.

To reduce potential radio interference to other users, the antenna type and its gain should be so chosen that the equivalent isotropically radiated power (e.i.r.p.) is not more than that permitted for successful communication.

This device complies with Industry Canada licence-exempt RSS standard(s). Operation is subject to the following two conditions:

1. This device may not cause interference, and
2. This device must accept any interference, including interference that may cause undesired operation of the device.

Cet appareil numérique de la classe A est conforme à la norme NMB-003 Canada.

Pour réduire le risque d'interférence aux autres utilisateurs, le type d'antenne et son gain doivent être choisis de façon que la puissance isotrope rayonnée équivalente (PIRE) ne dépasse pas ce qui est nécessaire pour une communication réussie.

Cet appareil est conforme à la norme RSS Industrie Canada exempts de licence norme(s). Son fonctionnement est soumis aux deux conditions suivantes:

1. Cet appareil ne peut pas provoquer d'interférences et
2. Cet appareil doit accepter toute interférence, y compris les interférences qui peuvent causer un mauvais fonctionnement du dispositif.

## RF Exposure Warning

The antennas used for this transmitter must be installed to provide a separation distance of at least 20 cm from all persons and must not be located or operating in conjunction with any other antenna or transmitter.

Les antennes utilisées pour ce transmetteur doivent être installées en considérant une distance de séparation de toute personne d'au moins 20 cm et ne doivent pas être localisées ou utilisées en conflit avec toute autre antenne ou transmetteur.

## CE Marking

CE marking on this product represents the product is in compliance with all directives that are applicable to it.

## Alert Sign (!) Follows CE Marking

Alert sign must be indicated if a restriction on use applied to the product and it must follow the CE marking.



## RoHS/WEEE Compliance Statement



### English

European Directive 2002/96/EC requires that the equipment bearing this symbol on the product and/or its packaging must not be disposed of with unsorted municipal waste. The symbol indicates that this product should be disposed of separately from regular household waste streams. It is your responsibility to dispose of this and other electric and electronic equipment via designated collection facilities appointed by the government or local authorities. Correct disposal and recycling will help prevent potential negative consequences to the environment and human health. For more detailed information about the disposal of your old equipment, please contact your local authorities, waste disposal service, or the shop where you purchased the product.

### Deutsch

Die Europäische Richtlinie 2002/96/EC verlangt, dass technische Ausrüstung, die direkt am Gerät und/oder an der Verpackung mit diesem Symbol versehen ist, nicht zusammen mit unsortiertem Gemeindeabfall entsorgt werden darf. Das Symbol weist darauf hin, dass das Produkt von regulärem Haushaltsmüll getrennt entsorgt werden sollte. Es liegt in Ihrer Verantwortung, dieses Gerät und andere elektrische und elektronische Geräte über die dafür zuständigen und von der Regierung oder örtlichen Behörden dazu bestimmten Sammelstellen zu entsorgen. Ordnungsgemäßes Entsorgen und Recyceln trägt dazu bei, potentielle negative Folgen für Umwelt und die menschliche Gesundheit zu vermeiden. Wenn Sie weitere Informationen zur Entsorgung Ihrer Altgeräte benötigen, wenden Sie sich bitte an die örtlichen Behörden oder städtischen Entsorgungsdienste oder an den Händler, bei dem Sie das Produkt erworben haben.

## Español

La Directiva 2002/96/CE de la UE exige que los equipos que lleven este símbolo en el propio aparato y/o en su embalaje no deben eliminarse junto con otros residuos urbanos no seleccionados. El símbolo indica que el producto en cuestión debe separarse de los residuos domésticos convencionales con vistas a su eliminación. Es responsabilidad suya desechar este y cualesquiera otros aparatos eléctricos y electrónicos a través de los puntos de recogida que ponen a su disposición el gobierno y las autoridades locales. Al desechar y reciclar correctamente estos aparatos estará contribuyendo a evitar posibles consecuencias negativas para el medio ambiente y la salud de las personas. Si desea obtener información más detallada sobre la eliminación segura de su aparato usado, consulte a las autoridades locales, al servicio de recogida y eliminación de residuos de su zona o pregunte en la tienda donde adquirió el producto.

## Français

La directive européenne 2002/96/CE exige que l'équipement sur lequel est apposé ce symbole sur le produit et/ou son emballage ne soit pas jeté avec les autres ordures ménagères. Ce symbole indique que le produit doit être éliminé dans un circuit distinct de celui pour les déchets des ménages. Il est de votre responsabilité de jeter ce matériel ainsi que tout autre matériel électrique ou électronique par les moyens de collecte indiqués par le gouvernement et les pouvoirs publics des collectivités territoriales. L'élimination et le recyclage en bonne et due forme ont pour but de lutter contre l'impact néfaste potentiel de ce type de produits sur l'environnement et la santé publique. Pour plus d'informations sur le mode d'élimination de votre ancien équipement, veuillez prendre contact avec les pouvoirs publics locaux, le service de traitement des déchets, ou l'endroit où vous avez acheté le produit.

## Italiano

La direttiva europea 2002/96/EC richiede che le apparecchiature contrassegnate con questo simbolo sul prodotto e/o sull'imballaggio non siano smaltite insieme ai rifiuti urbani non differenziati. Il simbolo indica che questo prodotto non deve essere smaltito insieme ai normali rifiuti domestici. È responsabilità del proprietario smaltire sia questi prodotti sia le altre apparecchiature elettriche ed elettroniche mediante le specifiche strutture di raccolta indicate dal governo o dagli enti pubblici locali. Il corretto smaltimento ed il riciclaggio aiuteranno a prevenire conseguenze potenzialmente negative per l'ambiente e per la salute dell'essere umano. Per ricevere informazioni più dettagliate circa lo smaltimento delle vecchie apparecchiature in Vostro possesso, Vi invitiamo a contattare gli enti pubblici di competenza, il servizio di smaltimento rifiuti o il negozio nel quale avete acquistato il prodotto.

## Declaration of Conformity

Česky [Czech]	UBIQUITI NETWORKS tímto prohlašuje, že toto UBIQUITI NETWORKS zařízení, je ve shod se základními požadavky a dalšími příslušnými ustanoveními směrnice 1999/5/ES.
Dansk [Danish]	Hermed, UBIQUITI NETWORKS, erklærer at denne UBIQUITI NETWORKS enhed, er i overensstemmelse med de væsentlige krav og øvrige relevante krav i direktiv 1999/5/EF.
Nederlands [Dutch]	Hierbij verklaart UBIQUITI NETWORKS, dat deze UBIQUITI NETWORKS apparaat, in overeenstemming is met de essentiële eisen en de andere relevante bepalingen van richtlijn 1999/5/EC.
English	Hereby, UBIQUITI NETWORKS, declares that this UBIQUITI NETWORKS device, is in compliance with the essential requirements and other relevant provisions of Directive 1999/5/EC.
Eesti [Estonian]	Käesolevaga UBIQUITI NETWORKS kinnitab, et antud UBIQUITI NETWORKS seade, on vastavus oluliste nõuetele ja teistele asjakohastele sätetele direktiivi 1999/5/EÜ.
Suomi [Finnish]	Täten UBIQUITI NETWORKS vakuuttaa, että tämä UBIQUITI NETWORKS laite, on yhdenmukainen olennaisten vaatimusten ja muiden sitä koskevien direktiivin 1999/5/EY.
Français [French]	Par la présente UBIQUITI NETWORKS déclare que l'appareil UBIQUITI NETWORKS, est conforme aux exigences essentielles et aux autres dispositions pertinentes de la directive 1999/5/CE.
Deutsch [German]	Hiermit erklärt UBIQUITI NETWORKS, dass sich dieses UBIQUITI NETWORKS Gerät, in Übereinstimmung mit den grundlegenden Anforderungen und den anderen relevanten Vorschriften der Richtlinie 1999/5/EG befindet.
Ελληνική [Greek]	Δια του παρόντος, UBIQUITI NETWORKS, δηλώνει ότι αυτή η συσκευή UBIQUITI NETWORKS, είναι σε συμμόρφωση με τις βασικές απαιτήσεις και τις λοιπές σχετικές διατάξεις της οδηγίας 1995/5/EK.
Magyar [Hungarian]	Ezennel UBIQUITI NETWORKS kijelenti, hogy ez a UBIQUITI NETWORKS készülék megfelel az alapvető követelményeknek és más vonatkozó 1999/5/EK irányelv rendelkezéseit.
Íslenska [Icelandic]	Hér, UBIQUITI NETWORKS, því yfir að þetta UBIQUITI NETWORKS tæki er í samræmi við grunnkröfur og önnur viðeigandi ákvæði tilskipun 1999/5/EC.
Italiano [Italian]	Con la presente, UBIQUITI NETWORKS, dichiara che questo dispositivo UBIQUITI NETWORKS, è conforme ai requisiti essenziali ed alle altre disposizioni pertinenti della direttiva 1999/5/CE.
Latviski [Latvian]	Ar šo, UBIQUITI NETWORKS, deklarē, ka UBIQUITI NETWORKS ierīce, ir saskaņā ar būtiskajām prasībām un citiem attiecīgiem noteikumiem Direktīvā 1999/5/EK.
Lietuviškai [Lithuanian]	UBIQUITI NETWORKS deklaruoja, kad šis UBIQUITI NETWORKS įrenginys atitinka esminius reikalavimus ir kitas 1999/5/EB Direktyvos nuostatas.

Malti [Maltese]	Hawnhekk, UBIQUITI NETWORKS, tiddikjara li dan il-mezz UBIQUITI NETWORKS huwa konformi mar-rekwiżiti essenzjali u dispożizzjonijiet rilevanti oħrajn ta 'Direttiva 1999/5/EC.
Norsk [Norwegian]	Herved UBIQUITI NETWORKS, erklærer at denne UBIQUITI NETWORKS enheten, er i samsvar med de grunnleggende kravene og andre relevante bestemmelser i direktiv 1999/5/EF.
Slovensky [Slovak]	Týmto UBIQUITI NETWORKS, prehlasuje, že toto UBIQUITI NETWORKS zariadenie, je v súlade so základnými požiadavkami a ďalšími relevantnými ustanoveniami smernice 1999/5/ES.
Svenska [Swedish]	Härmed UBIQUITI NETWORKS, intygar att denna UBIQUITI NETWORKS enhet är i överensstämmelse med de väsentliga egenskapskrav och övriga relevanta bestämmelser som framgår av direktiv 1999/5/EG.
Español [Spanish]	Por medio de la presente UBIQUITI NETWORKS declara que este dispositivo UBIQUITI NETWORKS, cumple con los requisitos esenciales y cualesquiera otras disposiciones aplicables o exigibles de la Directiva 1999/5/CE.
Polski [Polish]	Niniejszym, Ubiquiti Networks, oświadcza, że urządzenie UBIQUITI NETWORKS, jest zgodny z zasadniczymi wymaganiami oraz pozostałymi stosownymi postanowieniami Dyrektywy 1999/5/EC.
Português [Portuguese]	UBIQUITI NETWORKS declara que este dispositivo UBIQUITI NETWORKS, está conforme com os requisitos essenciais e outras disposições da Directiva 1999/5/CE.
Română [Romanian]	Prin prezenta, UBIQUITI NETWORKS declară că acest dispozitiv UBIQUITI NETWORKS este în conformitate cu cerințele esențiale și alte prevederi relevante ale Directivei 1999/5/CE.

## Online Resources

Support [support.ubnt.com](http://support.ubnt.com)

Community [community.ubnt.com](http://community.ubnt.com)

Downloads [downloads.ubnt.com](http://downloads.ubnt.com)



[www.ubnt.com](http://www.ubnt.com)

©2013-2015 Ubiquiti Networks, Inc. All rights reserved. Ubiquiti, Ubiquiti Networks, the Ubiquiti U logo, the Ubiquiti beam logo, airGrid, airMAX, airOS, InnerFeed, and TOUGH Cable are trademarks or registered trademarks of Ubiquiti Networks, Inc. in the United States and in other countries. All other trademarks are the property of their respective owners.

PH080815