

## ANTENNAS | OMNI-600 SERIES

# OMNI-600-02

## HIGH PERFORMANCE 2X2 MIMO LINEAR 410MHZ – 3800MHZ ANTENNA

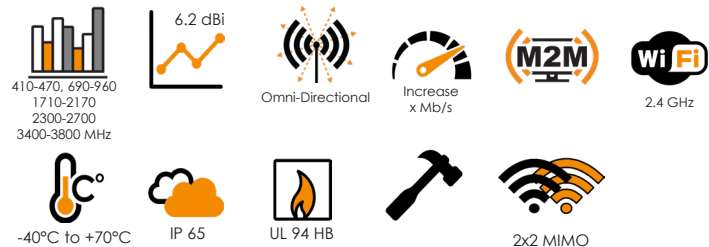

- **2x2 MIMO High Performance Omni Directional Antenna**
- **Consistent gain over a very wide frequency band**
- **Increased connectivity stability**

### Product Overview

The OMNI-600-02 is a unique new design with improved 2x2 MIMO electrical performance. The ultra-wide band covers all contemporary operating frequencies with excellent balanced gain across all frequencies. Higher frequencies are not compromised and the antenna design allows Poynting to have superior pattern control over the entire frequency range, making the OMNI-600-02 a true high performance omni-directional antenna. Usable in all parts of the world, the OMNI-600-02 guarantees signal reception almost everywhere. Poynting Antennas achieves this through new antenna configuration using multiple dipoles and a unique (patented) feed network. The antenna is future proof as it covers the 450MHz frequency and 3.5GHz CBRS band which is gaining popularity in various regions and countries.

### Features

- Medium gain omni-directional antenna
- 2x2 MIMO
- Robust and weather resistant
- 2.4 - 2.5 Ghz band can be used as WiFi antenna

### Application areas

- Machine to machine (M2M)
- Poor data signal reception (indoor or outdoor)
- Slow data transmission connection
- Unstable connection
- Increase system transmission reliability
- Wi-Fi Applications



## Frequency bands

The OMNI-600-02 is a 410 - 470 MHz | 690 - 960 MHz | 1710 - 2700 MHz | 3400 - 3800 MHz

 Indicates the bands on which this antenna works

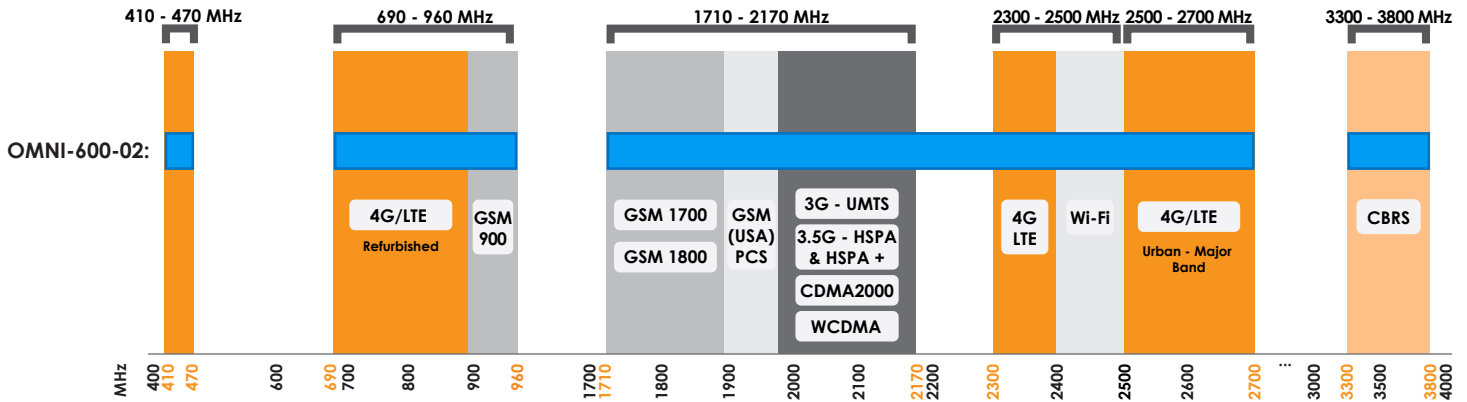

## Antenna Overview

	
Frequency Bands	410 MHz - 2700 MHz
Peak Gain	6.2 dBi
Coax Cable Type	Twin Siamese HDF 195
Coax Cable Length	2m
Connector Type	2 x SMA male

## Technical Drawing

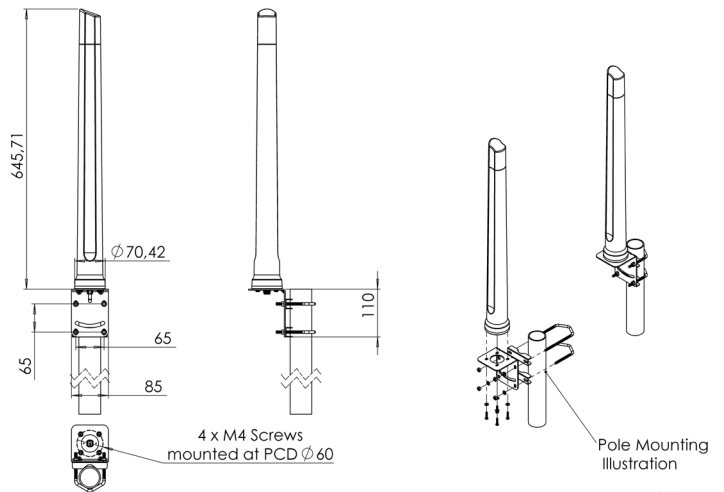

## Antenna Performance Plots

### VSWR:

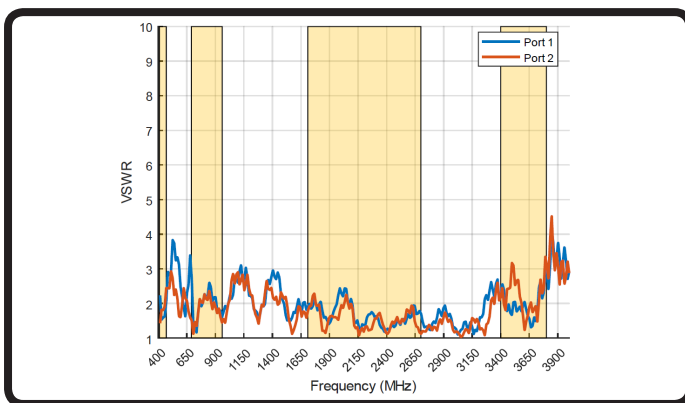

### Voltage Standing Wave Ratio (VSWR)

VSWR is a measure of how efficiently radio-frequency power is transmitted from a power source, through a transmission line, into a load. In an ideal system, 100% of the energy is transmitted which corresponds to a VSWR of 1:1.

The OMNI-600-02 delivers superior performance across all bands with a VSWR of <math><2.5:1</math> across 92% of the band.

\* Measured with 2m low loss cable

### Gain: (excluding cable loss)

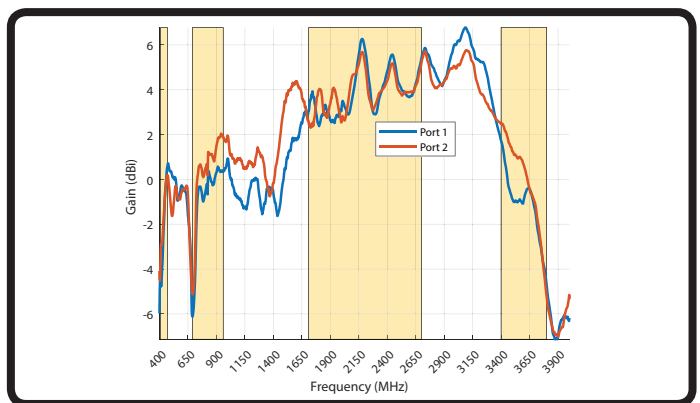

### Gain\* in dBi

6.2 dBi is the peak gain across all bands from 410 - 3800 MHz.

Gain @ different bands: Band 1 0.75 dBi @ 452-468 MHz  
 Gain @ different bands: Band 2 2.0 dBi @ 790-960 MHz  
 Gain @ different bands: Band 3 6.2 dBi @ 1710-2700MHz  
 Gain @ different bands: Band 4 2.2 dBi @ 3400-3800MHz

\*Antenna gain measured with polarisation aligned standard

Azimuth: 410-470 MHz

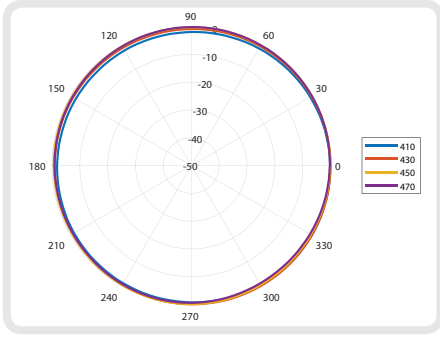

Azimuth: 690-960 MHz

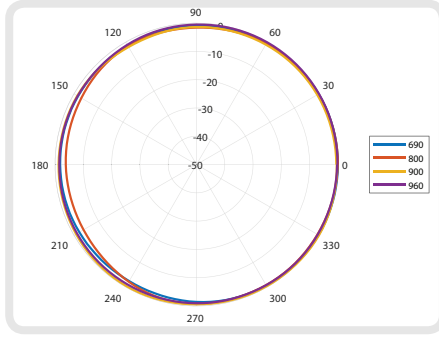

Azimuth: 1710-2100 MHz

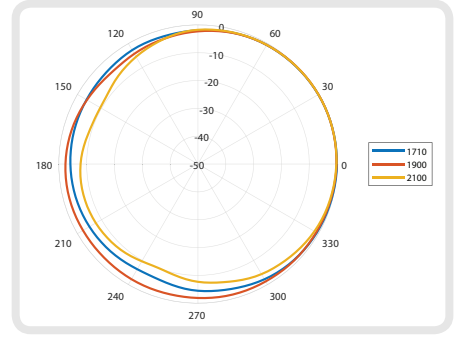

Azimuth: 2300-2700 MHz

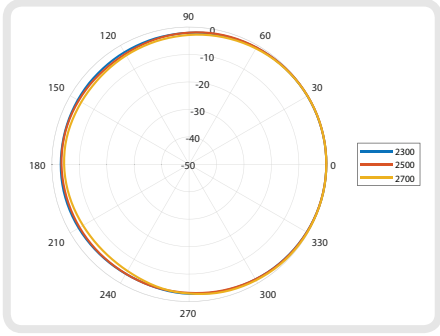

Azimuth: 3400-3800 MHz

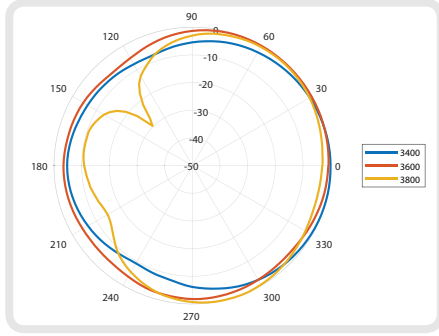

Elevation 1: 410-470 MHz

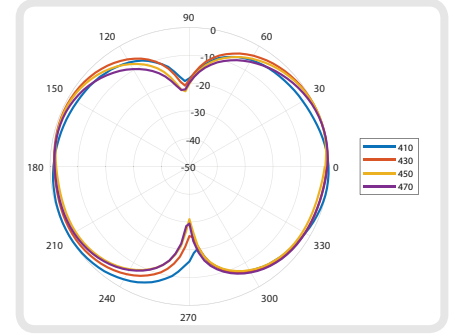

Elevation 1: 690-960 MHz

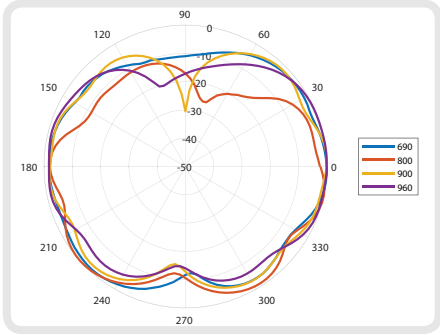

Elevation 1: 1710-2100 MHz

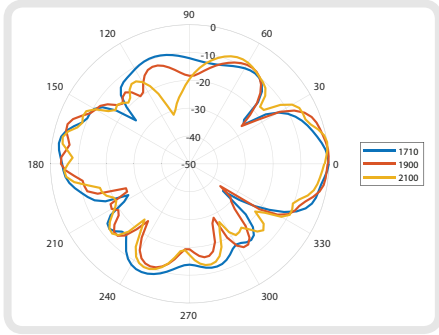

Elevation 1: 2300-2700 MHz

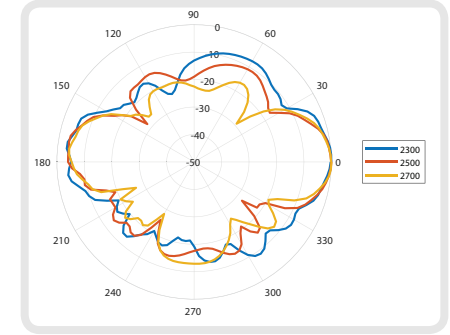

Elevation 1: 3400-3800 MHz

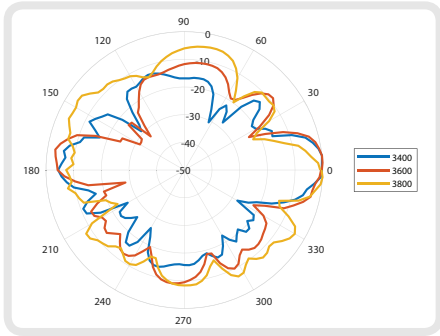

Elevation 2: 410-170 MHz

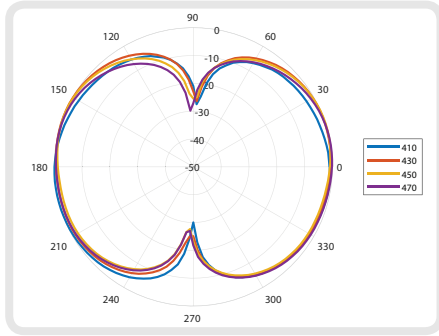

Elevation 2: 690-960 MHz

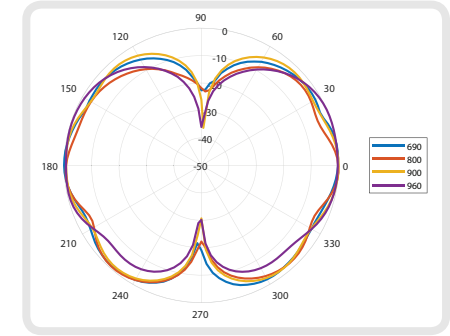

Elevation 2: 1710-2100 MHz

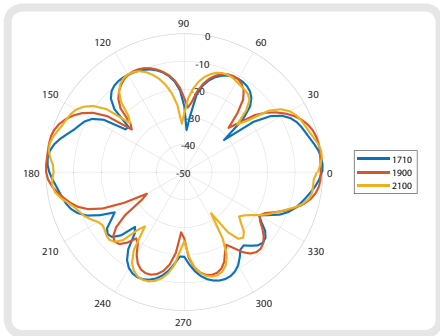

Elevation 2: 2300-2700 MHz

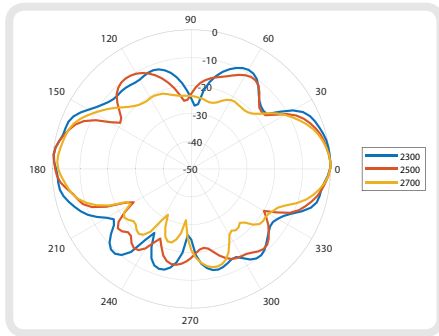

Elevation 2: 3400-3800MHz

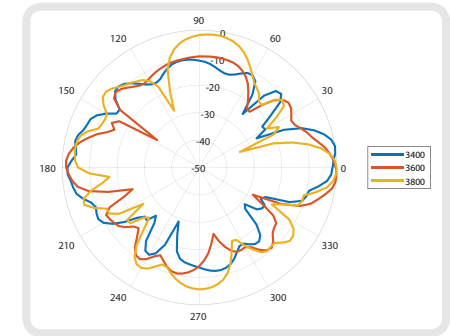

Azimuth: 410-470 MHz

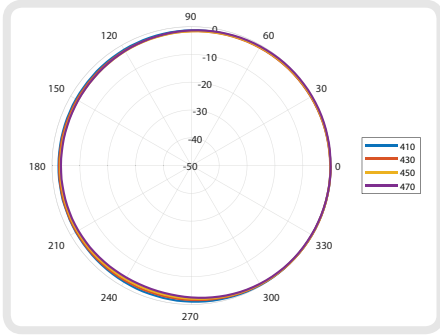

Azimuth: 690-960 MHz

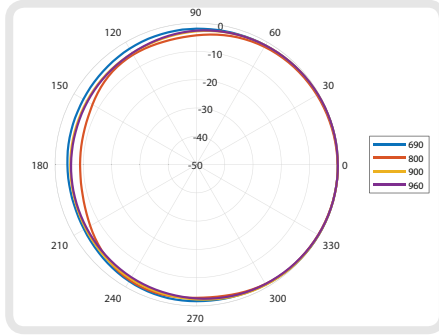

Azimuth: 1710-2100 MHz

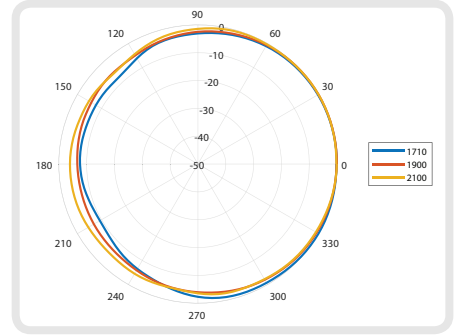

Azimuth: 2300-2700 MHz

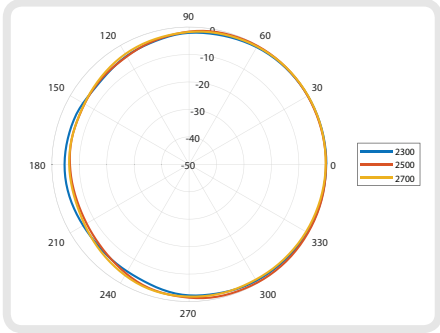

Azimuth: 3400-3800 MHz

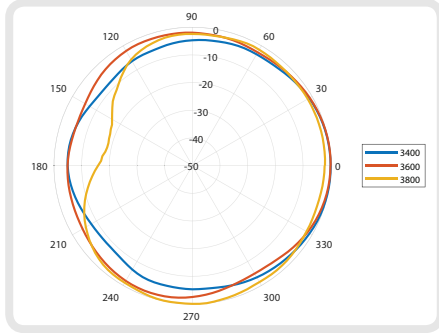

Elevation 1: 410-470 MHz

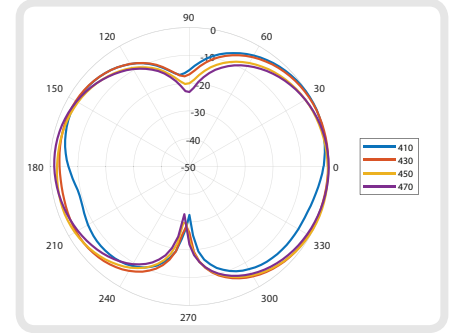

Elevation 1: 690-960 MHz

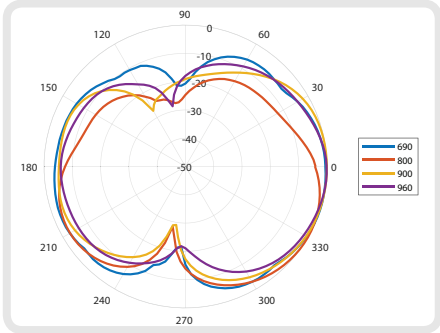

Elevation 1: 1710-2100 MHz

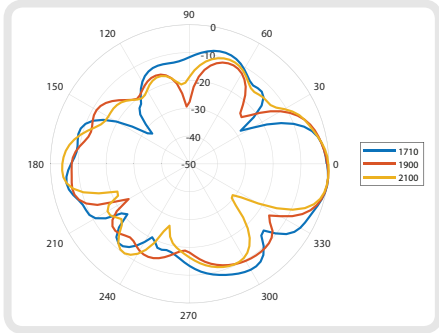

Elevation 1: 2300-2700 MHz

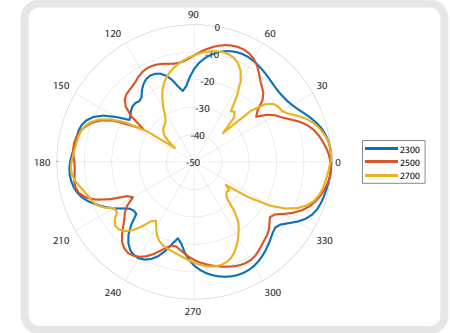

Elevation 1: 3400-3800 MHz

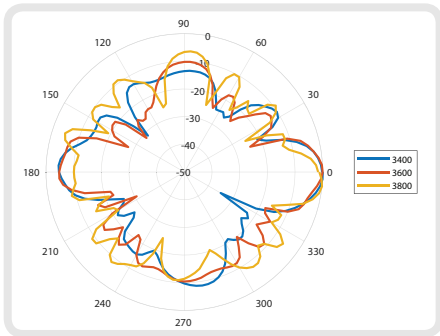

Elevation 2: 410-170 MHz

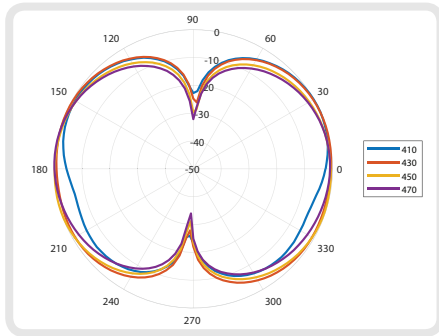

Elevation 2: 690-960 MHz

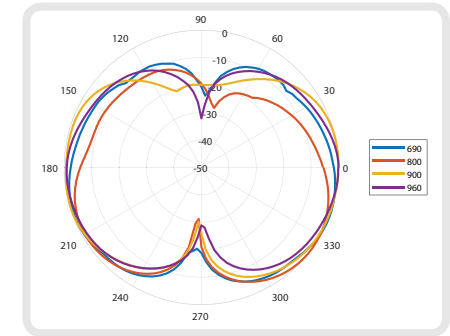

Elevation 2: 1710-2100 MHz

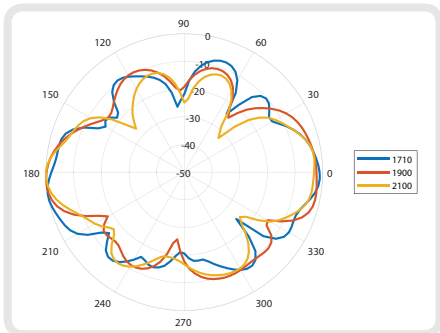

Elevation 2: 2300-2700 MHz

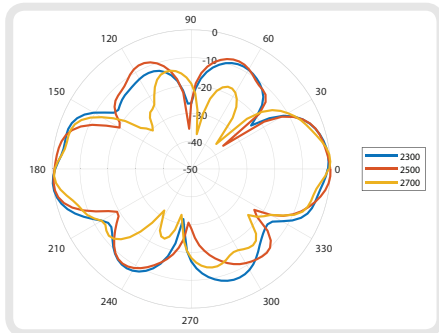

Elevation 2: 3400-3800MHz

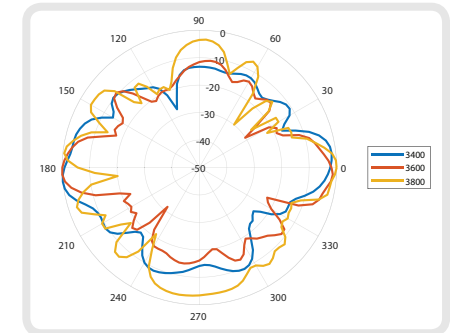

## Electrical Specifications

Frequency Bands:	410 - 470 MHz 690 - 960 MHz 1710 - 2700 MHz 3400 - 3800 MHz
Gain (Max) Port 1 & 2:	6.2 dBi
VSWR Port 1 & Port 2:	≤ 3 over 84% of the band
Feed Power Handling:	10 W
Input impedance:	50 Ohm (nominal)
Polarisation:	Linear Vertical
Cable loss:	0.35 dB/m @ 900 MHz 0.53 dB/m @ 2000 MHz 0.6 dB/m @ 2500 MHz
DC Short:	Yes
Cable Length:	5M ±5%
Cable Type:	Twin Siamese HDF 195
Connector:	2 x SMA male

## Environmental Specifications

Wind Survival:	<160km/h
Temperature Range (Operating):	-40°C to +70°C
Environmental Conditions:	Outdoor/Indoor
Operating Relative Humidity:	Up to 98%
Storage Humidity:	5% to 95% - non condensing
Storage Temperature:	-40°C to +70°C

## Ordering Information

Commercial name:	OMNI-600-02
Order Product Code:	A-OMNI-0600-V1-02
EAN number:	6009880915101

## Additional Accessories Available

Extension Cables:	Up to 15m HDF 195
Various connectors available	
Installation poles and brackets available	

For more detailed information and availability in your region, visit our website: [www.poynting.tech](http://www.poynting.tech)

## Contact Poynting

### Poynting Antennas (Pty) Ltd - Head Office

Unit 4, N1 Industrial Park  
Landmarks Avenue,  
Samrand, 0157  
South Africa

**Phone:** +27 (0) 12 657 0050

**E-mail:** [sales@poynting.co.za](mailto:sales@poynting.co.za)

## Mechanical Specifications

Product Dimensions (L x W):	750 x 75mm
Packaged Dimensions:	770 x 95 x 90mm
Weight:	TBC
Packaged Weight:	TBC
Radome Material:	ABS (Halogen Free)
Radome Colour:	Pantone - Cool Gray (1C) RAL - 7047

## Product Box Contents

Antenna:	A-OMNI-0600-V1-02
Mounting Bracket:	Pole up to 50mm diameter Wall and Pole mount stainless steel bracket

## Certification Approvals and Standards

Flammability rating:	UL 94-HB
Water Ingress Protection Ratio/Standard:	IP 65
Impact resistance:	IK 08
Salt Spray:	MIL-STD 810F /ASTM B117
Product Safety:	Complies with UL, CE, EN, CSA and IEC standards

